

# Conduits de fumée

The Energy To Meet Your Needs

L'énergie pour répondre à vos besoins. Vos clients souhaitent bénéficier du confort et du plaisir de l'eau chaude et c'est à vous qu'ils s'en remettent pour leur apporter ce service.

A.O. Smith vous épaula en étant responsable de la conception, de la fabrication, du transport et du conseil technique, qu'il s'agisse de générateurs solaires, directs gaz ou de chauffe-eau électriques. Tous nos procédés sont conformes aux normes européennes en matière de qualité et de performances. A.O. Smith vous offre un large éventail de produits, et un savoir-faire reposant sur plus de 50 années d'expérience dans la fourniture de systèmes fiables d'approvisionnement en eau chaude.

# Table des matières

	Page		Page
<b>BFC</b>		<b>TWI</b>	
Dimensions configurations BFC 28-60	3	Dimensions configurations TWI	27
Dimensions configurations BFC 80-120	4	Conduits de fumée catégorie B23 incl. art.no.	28
Conduits de fumée catégorie B23 incl. art.no.	5	Conduits de fumée catégorie C13 incl. art.no.	29
Conduits de fumée catégorie C13 incl. art.no.	6	Conduits de fumée catégorie C33 incl. art.no.	30
Conduits de fumée catégorie C33 incl. art.no.	7	Conduits de fumée catégorie C53 incl. art.no.	31
Conduits de fumée catégorie C53 incl. art.no.	8	Additional Conduits de fumée TWI	32
Additional Conduits de fumée BFC	9		
<b>Innovo</b>		<b>TWI II</b>	
Conduits de fumée Innovo Système Concentric - Ø80 / 125	11	Conduits de fumée TWI II Système Concentric - Ø80 / 125	33
Conduits de fumée Innovo Système Parallèle - 2 x Ø80	12	Conduits de fumée TWI II Système Parallèle - 2 x Ø80	34
<b>SGE</b>		<b>BFM</b>	
Dimensions configurations SGE	13	Dimensions configurations BFM 30-80	35
Conduits de fumée catégorie B23 incl. art.no.	14	Dimensions configurations BFM 100-120	36
Conduits de fumée catégorie C13 incl. art.no.	15	Conduits de fumée catégorie C13 incl. art.no.	37
Conduits de fumée catégorie C33 incl. art.no.	16	Conduits de fumée catégorie C33 incl. art.no.	38
Conduits de fumée catégorie C53 incl. art.no.	17	Additional Conduits de fumée BFM	39
Additional Conduits de fumée SGE	18		
<b>SGS</b>		<b>Matériel standard</b>	
Dimensions configurations SGS 28-60	19		40
Dimensions configurations SGS 80-120	20	<b>Contact</b>	
Conduits de fumée catégorie B23 incl. art.no.	21		41
Conduits de fumée catégorie C13 incl. art.no.	22		
Conduits de fumée catégorie C33 incl. art.no.	23		
Conduits de fumée catégorie C53 incl. art.no.	24		
Additional Conduits de fumée SGS	25		

# Configuration ventouse BFC 28 / 30 / 50 / 60

Evacuation coaxiale murale

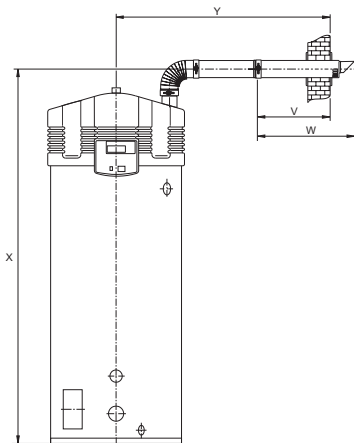

Configuration de la ventouse sortie murale

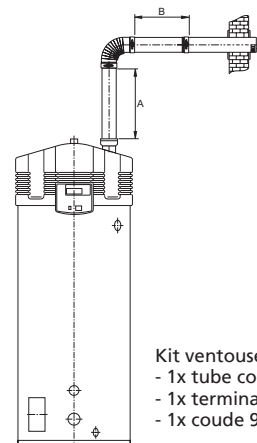

Kit ventouse mural (standard):  
 - 1x tube coaxial, 500 mm  
 - 1x terminal ventouse  
 - 1x coude 90°

	BFC 28	BFC 30	BFC 50	BFC 60
	Ø100/150	Ø100/150	Ø100/150	Ø100/150
V	550	550	550	550
W	790	790	790	790
X	1535	1535	1535	1535
Y	1480	1480	1480	1480
Y*	1030	1030	1030	1030

	BFC 28		BFC 30		BFC 50		BFC 60	
	min.	max.	min.	max.	min.	max.	min.	max.
A	0	40000	0	40000	0	40000	0	40000
B	0	40000	0	40000	0	40000	0	40000
A+B	<40000		<40000		<40000		<40000	
coudes	max. 7x45°/90°		max. 7x45°/90°		max. 7x45°/90°		max. 7x45°/90°	

- Dimensions en mm
- \* Distance sans tube concentrique entre coude et terminal mural

- Dimensions en mm

**Tuyau:**  
 Une inclinaison minimale de 5cm par mètre en horizontal en direction de l'appareil

Evacuation coaxiale toiture

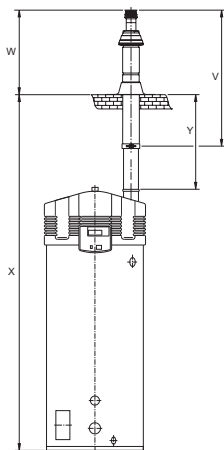

Configuration de la ventouse sortie toiture

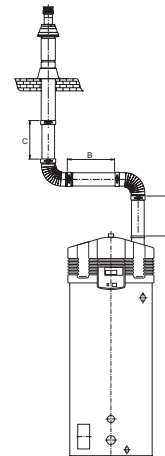

Kit ventouse toiture:  
 - 1x tube coaxial, 1000 mm  
 - 1x terminal ventouse  
 - 1x plaque toiture

	BFC 28	BFC 30	BFC 50	BFC 60
	Ø100/150	Ø100/150	Ø100/150	Ø100/150
V	1500	1500	1500	1500
W	1035	1035	1035	1035
X	2965	2965	2965	2965
X*	2015	2015	2015	2015
Y	1415	1415	1415	1415
Y*	465	465	465	465

	BFC 28		BFC 30		BFC 50		BFC 60	
	min.	max.	min.	max.	min.	max.	min.	max.
A	0	40000	0	40000	0	40000	0	40000
B	0	40000	0	40000	0	40000	0	40000
C	0	40000	0	40000	0	40000	0	40000
A+B+C	<40000		<40000		<40000		<40000	
coudes	max. 7x45°/90°		max. 7x45°/90°		max. 7x45°/90°		max. 7x45°/90°	

- Dimensions en mm
- \* Distance sans tube concentrique entre coude et terminal mural

- Dimensions en mm

**Tuyau:**  
 Une inclinaison minimale de 5cm par mètre en horizontal en direction de l'appareil

# Configuration ventouse BFC 80 / 100 / 120

## Evacuation coaxiale murale

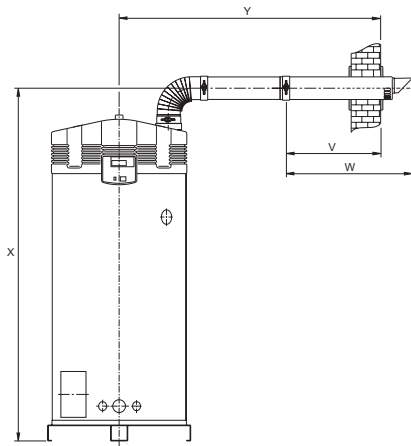

## Configuration de la ventouse sortie murale

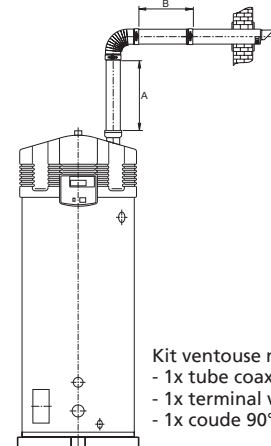

Kit ventouse mural (standard):  
 - 1x tube coaxial, 500 mm  
 - 1x terminal ventouse  
 - 1x coude 90°

	BFC 80	BFC 100	BFC 120
	Ø130/200	Ø130/200	Ø130/200
V	640	640	640
W	940	940	940
X	2230	2230	2230
Y	1620	1620	1620
Y*	1170	1170	1170

• Dimensions en mm

\* Distance sans tube concentrique entre coude et terminal mural

### Tuyau:

Une inclinaison minimale de 5cm par mètre en horizontal en direction de l'appareil

	BFC 80		BFC 100		BFC 120	
	min.	max.	min.	max.	min.	max.
A	0	15000	0	15000	0	15000
B	0	15000	0	15000	0	15000
A+B	<15000		<15000		<15000	
coudes	max. 4x45°/90°		max. 4x45°/90°		max. 4x45°/90°	

• Dimensions en mm

## Evacuation coaxiale toiture

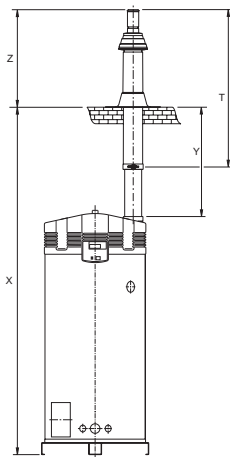

## Configuration de la ventouse sortie toiture

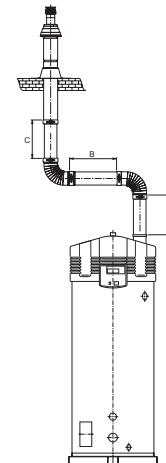

Kit ventouse toiture:  
 - 1x tube coaxial, 1000 mm  
 - 1x terminal ventouse  
 - 1x plaque toiture

	BFC 80	BFC 100	BFC 120
	Ø130/200	Ø130/200	Ø130/200
V	1730	1730	1730
W	1120	1120	1120
X	3620	3620	3620
X***	2670	2670	2670
Y	1560	1560	1560
Y***	610	610	610

• Dimensions en mm

\*\*\* Distance sans tube concentrique entre coude et terminal mural

### Tuyau:

Une inclinaison minimale de 5cm par mètre en horizontal en direction de l'appareil

	BFC 80		BFC 100		BFC 120	
	min.	max.	min.	max.	min.	max.
A	0	15000	0	15000	0	15000
B	0	15000	0	15000	0	15000
C	0	15000	0	15000	0	15000
A+B+C	<15000		<15000		<15000	
coudes	max. 4x45°/90°		max. 4x45°/90°		max. 4x45°/90°	

• Dimensions en mm

# Conduits BFC catégorie B23 incl. art.no.

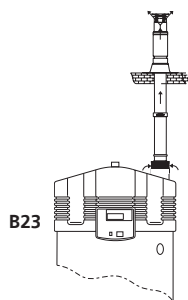

CATÉGORIE B23							
Description	BFC 28 Ø100/150	BFC 30 Ø100/150	BFC 50 Ø100/150	BFC 60 Ø100/150	BFC 80 Ø130/200	BFC 100 Ø130/200	BFC 120 Ø130/200
Grille de protection air frais	0304872	0304872	0304872	0304872	0307176	0307176	0307176
Terminal vertical	0305040	0305040	0305040	0305040	0307175	0307175	0307175
Plaque toiture ventouse vertical	0307173	0307173	0307173	0307173	0307174	0307174	0307174

Du 1er septembre 2009, la BFC 28 est équipé en standard de Ø100/150. Un adaptateur de Ø80/125 est disponible (réf. 0305009).

# Conduits de fumée BFC catégorie C13 incl. art.no.

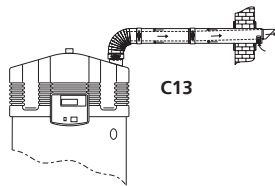

C13

CATÉGORIE C13							
Description	BFC 28 Ø100/150	BFC 30 Ø100/150	BFC 50 Ø100/150	BFC 60 Ø100/150	BFC 80 Ø130/200	BFC 100 Ø130/200	BFC 120 Ø130/200
Kit ventouse mural	0302504	0302504	0302504	0302504	0311465	0311465	0311465
Terminal mural *	0302505	0302505	0302505	0302505	0302313	0302313	0302313
Coude concentrique 45°	0311454	0311454	0311454	0311454	0311455	0311455	0311455
Coude concentrique 90°	0302502	0302502	0302502	0302502	0311456	0311456	0311456
Coude 500 mm	0302499	0302499	0302499	0302499	0302301	0302301	0302301
Coude 1000 mm	0311450	0311450	0311450	0311450	0311452	0311452	0311452
Coude 1500 mm	0311451	0311451	0311451	0311451	0311453	0311453	0311453
Collier de serrage Y-pièce	0302506(S)	0302506(S)	0302506(S)	0302506(S)	0302305(S)	0302305(S)	0302305(S)
Adaptateur concentrique	0306188 (Ø100/150 - Ø130/200)	0306188 (Ø100/150 - Ø130/200)	0306188 (Ø100/150 - Ø130/200)	0306188 (Ø100/150 - Ø130/200)	0306188 (Ø100/150 - Ø130/200)	0306188 (Ø100/150 - Ø130/200)	0306188 (Ø100/150 - Ø130/200)
Pièce de transformation concentrique / parallèle	0304204 (Ø100/150 - 2xØ100)	0304204 (Ø100/150 - 2xØ100)	0304204 (Ø100/150 - 2xØ100)	0304204 (Ø100/150 - 2xØ100)	0309605 (Ø130/200 - 2xØ130)	0309605 (Ø130/200 - 2xØ130)	0309605 (Ø130/200 - 2xØ130)
	0307135 (Ø100/150 - 2xØ130)	0307135 (Ø100/150 - 2xØ130)	0307135 (Ø100/150 - 2xØ130)	0307135 (Ø100/150 - 2xØ130)	-	-	-
Adaptateur parallèle/ concentrique	0307142 (2xØ100 - Ø100/150)	0307142 (2xØ100 - Ø100/150)	0307142 (2xØ100 - Ø100/150)	0307142 (2xØ100 - Ø100/150)	0306801 (2xØ130 - 1xØ200)	0306801 (2xØ130 - 1xØ200)	0306801 (2xØ130 - 1xØ200)
Tuyau concentrique avec graisseur de mesure	0303854 (Ø100/150)	0303854 (Ø100/150)	0303854 (Ø100/150)	0303854 (Ø100/150)	0303855 (Ø130/200)	0303855 (Ø130/200)	0303855 (Ø130/200)

\* incl. 2 plaques murales et collier de serrage.

# Conduits de fumée BFC catégorie C33 incl. art.no.

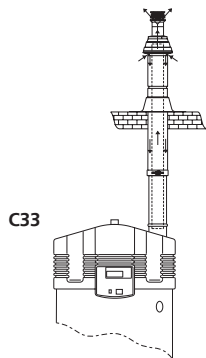

CATÉGORIE C33							
Description	BFC 28 Ø100/150	BFC 30 Ø100/150	BFC 50 Ø100/150	BFC 60 Ø100/150	BFC 80 Ø130/200	BFC 100 Ø130/200	BFC 120 Ø130/200
Kit ventouse toiture	0311463	0311463	0311463	0311463	0311464	0311464	0311464
Terminal vertical *	0311458	0311458	0311458	0311458	0306390	0306390	0306390
Plaque toiture	0302509	0302509	0302509	0302509	0302328	0302328	0302328
Coude concentrique 45°	0311454	0311454	0311454	0311454	0311455	0311455	0311455
Coude concentrique 90°	0302502	0302502	0302502	0302502	0311456	0311456	0311456
Tube concentrique 500 mm	0302499	0302499	0302499	0302499	0302301	0302301	0302301
Tube concentrique 1000 mm	0311450	0311450	0311450	0311450	0311452	0311452	0311452
Tube concentrique 1500 mm	0311451	0311451	0311451	0311451	0311453	0311453	0311453
Collier de serrage Y-pièce	0302506(S)	0302506(S)	0302506(S)	0302506(S)	0302305(S)	0302305(S)	0302305(S)
Adaptateur concentrique	0306188 (Ø100/150 - Ø130/200)	0306188 (Ø100/150 - Ø130/200)	0306188 (Ø100/150 - Ø130/200)	0306188 (Ø100/150 - Ø130/200)	0306188 (Ø100/150 - Ø130/200)	0306188 (Ø100/150 - Ø130/200)	0306188 (Ø100/150 - Ø130/200)
Pièce de transformation concentrique / parallèle	0304204 (Ø100/150 - 2xØ100)	0304204 (Ø100/150 - 2xØ100)	0304204 (Ø100/150 - 2xØ100)	0304204 (Ø100/150 - 2xØ100)	0309605 (Ø130/200 - 2xØ130)	0309605 (Ø130/200 - 2xØ130)	0309605 (Ø130/200 - 2xØ130)
	0307135 (Ø100/150 - 2xØ130)	0307135 (Ø100/150 - 2xØ130)	0307135 (Ø100/150 - 2xØ130)	0307135 (Ø100/150 - 2xØ130)	-	-	-
	0307142 (2xØ100 - Ø100/150)	0307142 (2xØ100 - Ø100/150)	0307142 (2xØ100 - Ø100/150)	0307142 (2xØ100 - Ø100/150)	0306801 (2xØ130 - 1xØ200)	0306801 (2xØ130 - 1xØ200)	0306801 (2xØ130 - 1xØ200)
Tuyau concentrique avec graisseur de mesure	0303854 (Ø100/150)	0303854 (Ø100/150)	0303854 (Ø100/150)	0303854 (Ø100/150)	0303855 (Ø130/200)	0303855 (Ø130/200)	0303855 (Ø130/200)

\* incl. 2 plaques murales et collier de serrage.

# Conduits de fumée BFC catégorie C53 incl. art.no.

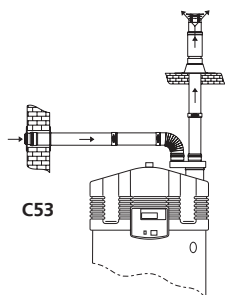

CATÉGORIE C53							
Description	BFC 28 Ø100/150	BFC 30 Ø100/150	BFC 50 Ø100/150	BFC 60 Ø100/150	BFC 80 Ø130/200	BFC 100 Ø130/200	BFC 120 Ø130/200
Terminal mural *	0305039 (Ø100)	0305039 (Ø100)	0305039 (Ø100)	0305039 (Ø100)	-	-	-
	0307178 (Ø130)	0307178 (Ø130)	0307178 (Ø130)	0307178 (Ø130)	0307178 (Ø130)	0307178 (Ø130)	0307178 (Ø130)
Terminal vertical	0305040 (Ø100)	0305040 (Ø100)	0305040 (Ø100)	0305040 (Ø100)	0307175 (Ø130)	0307175 (Ø130)	0307175 (Ø130)
Plaque toiture	0307173 (Ø120)	0307173 (Ø120)	0307173 (Ø120)	0307173 (Ø120)	0307174 (Ø160)	0307174 (Ø160)	0307174 (Ø160)
Adaptateur parallèle	0304204 (Ø100/150 - 2xØ100)	0304204 (Ø100/150 - 2xØ100)	0304204 (Ø100/150 - 2xØ100)	0304204 (Ø100/150 - 2xØ100)	-	-	-
	0307135 (Ø100/150 - 2xØ130)	0307135 (Ø100/150 - 2xØ130)	0307135 (Ø100/150 - 2xØ130)	0307135 (Ø100/150 - 2xØ130)	0309605 (Ø130/200 - 2xØ130)	0309605 (Ø130/200 - 2xØ130)	0309605 (Ø130/200 - 2xØ130)

\* incl. 2 plaques murales.

Du 1er septembre 2009, la BFC 28 est équipé en standard de Ø100/150. Un adaptateur de Ø80/125 est disponible (réf. 0305009).



# Conduits de fumée BFC



## KIT VENTOUSE VERTICAL - CONCENTRIQUE

Description	BFC 28	BFC 30	BFC 50	BFC 60	BFC 80	BFC 100	BFC 120
Ø 100 / 150	0311463	0311463	0311463	0311463	-	-	-
Ø 130 / 200	-	-	-	-	0311464	0311464	0311464

○ Incl. plaque et tube concentrique (1m)



## VENTOUSE VERTICAL - PARALLÈLE

Description	BFC 28	BFC 30	BFC 50	BFC 60	BFC 80	BFC 100	BFC 120
Ø 100	0305040	0305040	0305040	0305040	-	-	-
Ø 130	-	-	-	-	0307175	0307175	0307175



## PLAQUE TOITURE PARALLÈLE

Description	BFC 28	BFC 30	BFC 50	BFC 60	BFC 80	BFC 100	BFC 120
Terminal Plaque	-	-	-	-	-	-	-
Ø 100 Ø 120	0307173	0307173	0307173	0307173	-	-	-

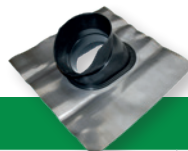

## PLAQUE TOITURE CONCENTRIQUE

Description	BFC 28	BFC 30	BFC 50	BFC 60	BFC 80	BFC 100	BFC 120
Ø 100 / 150	CoUDE 25°-45°	0306017	0306017	0306017	0306017	-	-
Ø 130 / 200	45°	-	-	-	-	0313847	0313847



## KIT VENTOUSE MURAL - CONCENTRIQUE

Description	BFC 28	BFC 30	BFC 50	BFC 60	BFC 80	BFC 100	BFC 120
Ø 100 / 150	0302504	0302504	0302504	0302504	-	-	-
Ø 130 / 200	-	-	-	-	0311465	0311465	0311465

○ Incl. tube (0,5m), coude concentrique (90°) et plaques murales

## VENTOUSE VERTICAL EXTENSION TUBE

Description	BFC 28	BFC 30	BFC 50	BFC 60	BFC 80	BFC 100	BFC 120
Ø 100/150 450mm	0311291	0311291	0311291	0311291	-	-	-
Ø 100/150 950mm	0311292	0311292	0311292	0311292	-	-	-

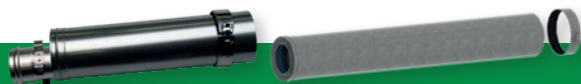

## TUBE - CONCENTRIQUE

Description	BFC 28	BFC 30	BFC 50	BFC 60	BFC 80	BFC 100	BFC 120
Ø 100 / 150 L = 500 mm	0302499	0302499	0302499	0302499	-	-	-
Ø 100 / 150 L = 1000 mm	0311450	0311450	0311450	0311450	-	-	-
Ø 100 / 150 L = 1500 mm	0311451	0311451	0311451	0311451	-	-	-
Ø 130 / 200 L = 500 mm	-	-	-	-	0302301	0302301	0302301
Ø 130 / 200 L = 1000 mm	-	-	-	-	0311452	0311452	0311452
Ø 130 / 200 L = 1500 mm	-	-	-	-	0311453	0311453	0311453

○ Découpable

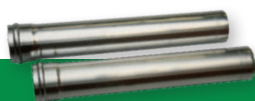

## TUBE - PARALLÈLE

Description	BFC 28	BFC 30	BFC 50	BFC 60	BFC 80	BFC 100	BFC 120
Ø 100 L = 500 mm	0307160	0307160	0307160	0307160	-	-	-
Ø 100 L = 1000 mm	0307161	0307161	0307161	0307161	-	-	-
Ø 130 L = 500 mm	-	-	-	-	0306804	0306804	0306804
Ø 130 L = 1000 mm	-	-	-	-	0306802	0306802	0306802

○ Ensemble de deux pièces

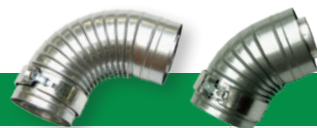

## COUDE - CONCENTRIQUE

Description	BFC 28	BFC 30	BFC 50	BFC 60	BFC 80	BFC 100	BFC 120
Ø 100 / 150 Coude 90°	0302502	0302502	0302502	0302502	-	-	-
Ø 100 / 150 Coude 45°	0311454	0311454	0311454	0311454	-	-	-
Ø 130 / 200 Coude 90°	-	-	-	-	0311456	0311456	0311456
Ø 130 / 200 Coude 45°	-	-	-	-	0311455	0311455	0311455

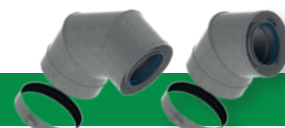

# Conduits de fumée BFC



## COUDE - PARALLÈLE

Description		BFC 28	BFC 30	BFC 50	BFC 60	BFC 80	BFC 100	BFC 120
Ø 100	Coude 45°	0310197	0310197	0310197	0310197	-	-	-
Ø 100	Coude 87/90°	0307164	0307164	0307164	0307164	-	-	-
Ø 130	Coude 87/90°	-	-	-	-	0306805	0306805	0306805
Ø 130	Coude 45°	-	-	-	-	0308026	0308026	0308026



## PIÈCE EN T - CONCENTRIQUE

Description	BFC 28	BFC 30	BFC 50	BFC 60	BFC 80	BFC 100	BFC 120
Ø 100 / 150	0305244	0305244	0305244	0305244	-	-	-



## GRILLE DE PROTECTION AIR FRAIS

Description	BFC 28	BFC 30	BFC 50	BFC 60	BFC 80	BFC 100	BFC 120
Ø 100 / 150	0304872	0304872	0304872	0304872	-	-	-
Ø 130 / 200	-	-	-	-	0307176	0307176	0307176



## ADAPTATEUR - CONC. DE PAR.

Description		BFC 28	BFC 30	BFC 50	BFC 60	BFC 80	BFC 100	BFC 120
De	à							
Ø 100 / 150	2 x Ø 100	0304204	0304204	0304204	0304204	-	-	-
Ø 130 / 200	2 x Ø 130	-	-	-	-	0309605	0309605	0309605



## ADAPTATEUR - CONC. DE CONC.

Description		BFC 28	BFC 30	BFC 50	BFC 60	BFC 80	BFC 100	BFC 120
De	à							
Ø 100 / 150	Ø 80 / 125	0309660	-	-	-	-	-	-
Ø 100 / 150	Ø 130 / 200	0306188	0306188	0306188	0306188	0306188	0306188	0306188



## ADAPTATEUR - PAR. DE CONC.

Description		BFC 28	BFC 30	BFC 50	BFC 60	BFC 80	BFC 100	BFC 120
De	à							
2 x Ø 100	1 x Ø 150	0307142	0307142	0307142	0307142	-	-	-



## ADAPTATEUR - PAR. DE PAR.

Description		BFC 28	BFC 30	BFC 50	BFC 60	BFC 80	BFC 100	BFC 120
De	à							
Ø 100	Ø 130	0307168	0307168	0307168	0307168	-	-	-
Ø 130	Ø 150	-	-	-	-	0307170	0307170	0307170



## COLLIER DE SERRAGE - PIÈCE EN Y AVEC TUBE

Description	BFC 28	BFC 30	BFC 50	BFC 60	BFC 80	BFC 100	BFC 120
Ø 154	0309632	0309632	0309632	0309632	0309442	0309442	0309442
Ø 206	-	-	-	-	0309442	0309442	0309442



## COLLIER DE SERRAGE - TUBE AVEC TUBE

Description	BFC 28	BFC 30	BFC 50	BFC 60	BFC 80	BFC 100	BFC 120
Ø 150	0302506(S)	0302506(S)	0302506(S)	0302506(S)	-	-	-
Ø 200	-	-	-	-	0302305(S)	0302305(S)	0302305(S)



## PLAQUE TOITURE - CONCENTRIQUE

Description		BFC 28	BFC 30	BFC 50	BFC 60	BFC 80	BFC 100	BFC 120
Terminal	Plaque							
Ø 100/150	Ø 170	0302509	0302509	0302509	0302509	-	-	-
Ø 130/200	Ø 210	-	-	-	-	0302328	0302328	0302328



## TUBE CONC. AVEC GRAISSEUR DE MESURE

Description	BFC 28	BFC 30	BFC 50	BFC 60	BFC 80	BFC 100	BFC 120
Ø 100 / 150	0303854	0303854	0303854	0303854	-	-	-
Ø 130 / 200	-	-	-	-	0303855	0303855	0303855

# Conduits de fumée Innovo Système Concentric - Ø 80 / 125



**TERMINAL TOITURE**

Description	Art. No.	
	Alu	PP
Ø80/125	0311457	0310753



**TERMINAL MURALE**

Description	Art. No.	
	Alu	PP
Ø80/125	0302516	0310757



**KIT VENTOUSE VERTICAL**

Description	Art. No.	
	Alu	PP
Ø80/125	0305042	0310755

○ Incl. plaque et tube concentrique (1m)



**KIT VENTOUSE MURALE**

Description	Art. No.	
	Alu	PP
Ø80/125	0302515	0310759

○ Incl. tube (0,5m), coude concentrique (90°) et plaques murales

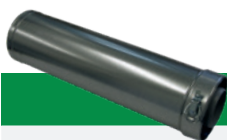

**CONCENTRIC TUBE**

Description	Art. No.	
	Alu	PP
Ø80/125 250 mm	-	0310740
Ø80/125 500 mm	0302510*	-
Ø80/125 1000 mm	0311448*	0310742
Ø80/125 1500 mm	0311449*	-
Ø80/125 2000 mm	-	0310743
Ø80/125 Telescopic (280-395 mm)	-	0310744
Ø80/125 500 mm	-	0310745*

\* Découpable



**COUDES**

Description		Art. No.	
		Alu	PP
Ø80/125	90°	0313776	0310735
Ø80/125	45°	0302514	0310734



**PIÈCE EN T + OBTURATEUR (PP)**

Description	Art. Nr.	
	Alu	PP
Ø80/125	0307487	0310738

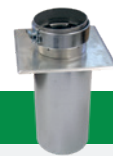

**PLAQUE MURALE (PP)**

Description	Art. No.
Ø125/150	0310761



**PLAQUE TOITURE**

Description		Art. No.
Terminal	Plaque	
Ø80/125	Ø140	0302520

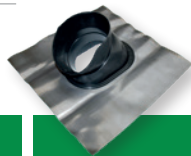

**PLAQUE TOITURE CONCENTRIQUE**

Description		Art. No.
Ø80/125	Coude 25°-45°	0303506



**GRILLE DE PROTECTION AIR FRAIS**

Description	Art. No.
Ø80/125	0305030

# Conduits de fumée Innovo Système Parallèle - 2 x Ø80



## TERMINAL TOITURE

Description	Art. No.
2 x Ø80	0310708



## KIT TERMINAL MURALE (PP)

Description	Art. No.
2 x Ø80	0310730

Incl. terminal murale, 2 coudes (90°) et 2 pièces

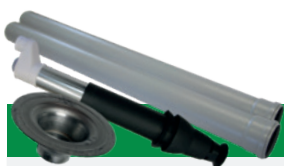

## KIT TERMINAL TOITURE (PP)

Description	Art. No.
2 x Ø80	0310712

Incl. terminal toiture, 2 tubes (1m) et plaque toiture



## VENTOUSE VERTICALE

Description	Art. No.
Ø 80	0305041

○ Incl. collier de serrage et adaptateur

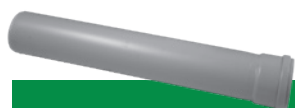

## TUBE

Description		Art. No.	
		Alu	PP
Ø80	250 mm	-	0310718
Ø80	500 mm	0307179	0310719
Ø80	1000 mm	0307180	0310720
Ø80	1500 mm	0307181	-
Ø80	2000 mm	-	0310721
Ø80	Telescopic	-	0310722



## COUDES (PP)

Description		Art. No.
Ø80	45°	0310701
Ø80	90°	0310702
Ø80	90° avec support	0310703



## COUDE



Description		Art. No.
Ø 80	Coude 45°	0307182
Ø 80	Coude 87 / 90°	0307183



## ADAPTATEUR - CONC. DE PAR.

Description		Art. No.
De	à	
Ø 80 / 125	2 x Ø 80	0312209

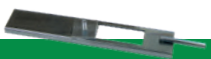

## SUPPORT POUR COUDE AVEC SUPPORT

Description	Art. No.
Ø80	0310690

# Configuration ventouse SGE 40 / 60

## Evacuation coaxiale murale

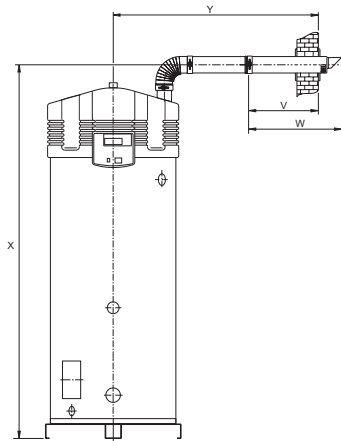

## Configuration de la ventouse sortie murale

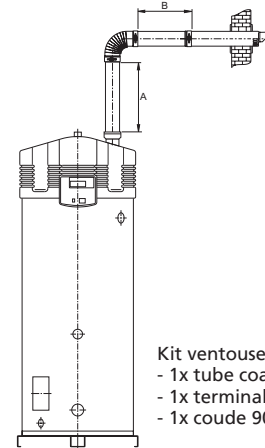

Kit ventouse mural (standard):  
 - 1x tube coaxial, 500 mm  
 - 1x terminal ventouse  
 - 1x coude 90°

	SGE 40	SGE 60
	Ø100/150	Ø100/150
V	550	550
W	790	790
X	2335	2335
Y	1475	1475
Y*	1025	1025

• Dimensions en mm  
 \* Distance sans tube concentrique entre coude et terminal mural

**Tuyau:**  
 Une inclinaison minimale de 5cm par mètre en horizontal en direction de l'appareil

	SGE 40		SGE 60	
	min.	max.	min.	max.
A	0	40000	0	40000
B	0	40000	0	40000
A+B	<40000		<40000	
coudes	max. 7x45°/90°		max. 7x45°/90°	

• Dimensions en mm

## Evacuation coaxiale toiture

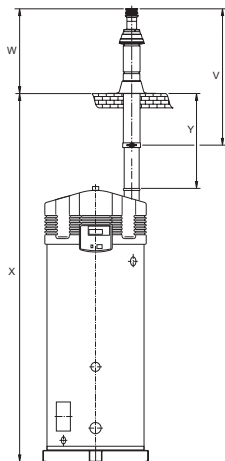

## Configuration de la ventouse sortie toiture

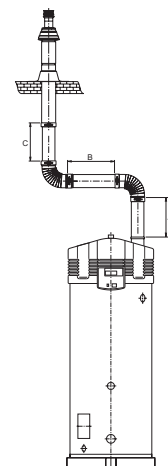

Kit ventouse toiture:  
 - 1x tube coaxial, 1000 mm  
 - 1x terminal ventouse  
 - 1x plaque toiture

	SGE 40	SGE 60
	Ø130/200	Ø130/200
V	1500	1500
W	1035	1035
X	3585	3585
X*	2520	2520
Y	1415	1415
Y*	465	465

• Dimensions en mm  
 \* Distance sans tube concentrique entre coude et terminal mural

**Tuyau:**  
 Une inclinaison minimale de 5cm par mètre en horizontal en direction de l'appareil

	SGE 40		SGE 60	
	min.	max.	min.	max.
A	0	40000	0	40000
B	0	40000	0	40000
C	0	40000	0	40000
A+B	<40000		<40000	
coudes	max. 7x45°/90°		max. 7x45°/90°	

• Dimensions en mm

# Conduits de fumée SGE catégorie B23 incl. art.no.

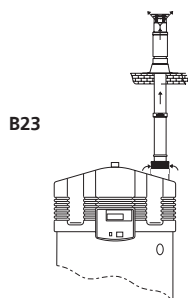

CATÉGORIE B23		
Description	SGE 40 Ø100/150	SGE 60 Ø100/150
Grille de protection air frais	0304872	0304872
Terminal vertical	0305040	0305040
Plaque toiture	0307173	0307173

# Conduits de fumée SGE catégorie C13 incl. art.no.

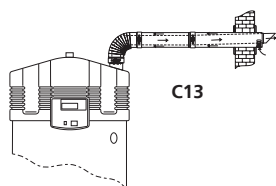

C13

CATÉGORIE C13		
Description	SGE 40 Ø100/150	SGE 60 Ø100/150
Kit ventouse mural	0302504	0302504
Terminal mural *	0302505	0302505
Coude concentrique 45°	0311454	0311454
Coude concentrique 90°	0302502	0302502
Tube concentrique 500 mm	0302499	0302499
Tube concentrique 1000 mm	0311450	0311450
Tube concentrique 1500 mm	0311451	0311451
Collier de serrage Y-pièce	0302506(S)	0302506(S)
Adaptateur concentrique	0306188 (Ø100/150 - Ø130/200)	0306188 (Ø100/150 - Ø130/200)
	0304204 (Ø100/150 - 2xØ100)	0304204 (Ø100/150 - 2xØ100)
Pièce de transformation concentrique / parallèle	0307135 (Ø100/150 - 2xØ130)	0307135 (Ø100/150 - 2xØ130)
	0307142 (2xØ100 - Ø100/150)	0307142 (2xØ100 - Ø100/150)
Adaptateur parallèle/ concentrique	0307142 (2xØ100 - Ø100/150)	0307142 (2xØ100 - Ø100/150)
Tuyau concentrique avec graisseur de mesure	0303854	0303854

\* incl. 2 plaques murales et collier de serrage.

# Conduits de fumée SGE catégorie C33 incl. art.no.

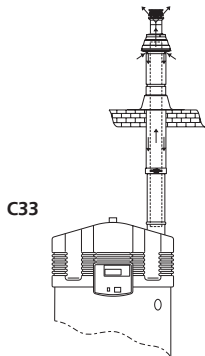

CATÉGORIE C33		
Description	SGE 40 Ø100/150	SGE 60 Ø100/150
Kit ventouse toiture	0311463	0311463
Terminal vertical	0311458	0311458
Plaque toiture	0302509	0302509
Coude concentrique 45°	0311454	0311454
Coude concentrique 90°	0302502	0302502
Tube concentrique 500 mm	0302499	0302499
Tube concentrique 1000 mm	0311450	0311450
Tube concentrique 1500 mm	0311451	0311451
Collier de serrage Y-pièce	0302506(S)	0302506(S)
Adaptateur concentrique	0306188 (Ø100/150 - Ø130/200)	0306188 (Ø100/150 - Ø130/200)
Pièce de transformation concentrique / parallèle	0304204 (Ø100/150 - 2xØ100)	0304204 (Ø100/150 - 2xØ100)
	0307135 (Ø100/150 - 2xØ130)	0307135 (Ø100/150 - 2xØ130)
Adaptateur parallèle/concentrique	0307142 (2xØ100 - Ø100/150)	0307142 (2xØ100 - Ø100/150)
Tuyau concentrique avec graisseur de mesure	0303854	0303854



# Conduits de fumée SGE catégorie C53 incl. art.no.

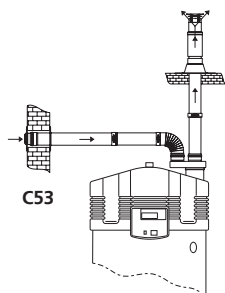

CATÉGORIE C53		
Description	SGE 40 Ø100/150	SGE 60 Ø100/150
Terminal mural *	0305039 (Ø100)	0305039 (Ø100)
	0307178 (Ø130)	0307178 (Ø130)
Terminal vertical	0305040 (Ø100)	0305040 (Ø100)
	0307175 (Ø130)	0307175 (Ø130)
Plaque toiture	0307173 (Ø100)	0307173 (Ø100)
Pièce de transformation concentrique / parallèle	0304204 (Ø100/150 - 2xØ100)	0304204 (Ø100/150 - 2xØ100)
	0307135 (Ø100/150 - 2xØ130)	0307135 (Ø100/150 - 2xØ130)

\* incl. 2 plaques murales.

# Conduits de fumée SGE



**VENTOUSE VERTICALE - PARALLÈLE**

Description	SGE 40	SGE 60
Ø 100	0305040	0305040



**KIT VENTOUSE VERTICALE - CONCENTRIQUE**

Description	SGE 40	SGE 60
Ø 100 / 150	0311463	0311463
○ Incl. plaque et tube concentrique (1m)		

**VENTOUSE VERTICALE EXTENSION TUBE**

Description	SGE 40	SGE 60
Ø 100/150 450mm	0311291	0311291
Ø 100/150 950mm	0311292	0311292



**PLAQUE TOITURE PARALLÈLE**

Description	SGE 40	SGE 60
Terminal	Plaque	
Ø 100	Ø 120	0307173 0307173
Ø 100 / 150	Ø 170	0302509 0302509

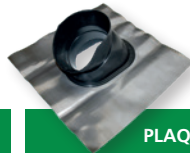

**PLAQUE TOITURE CONCENTRIQUE**

Description	SGE 40	SGE 60
Ø 100 / 150	CoUDE 25°-45°	0306017 0306017



**KIT VENTOUSE MURAL - CONCENTRIQUE**

Description	SGE 40	SGE 60
Ø 100 / 150	0302504	0302504
○ Incl. tube (0,5m), coude concentrique (90°) et plaques murales		

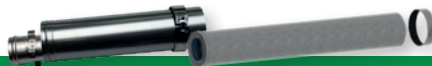

**TUBE - CONCENTRIQUE**

Description	SGE 40	SGE 60
Ø 100 / 150 L = 500 mm	0302499	0302499
Ø 100 / 150 L = 1000 mm	0311450	0311450
Ø 100 / 150 L = 1500 mm	0311451	0311451
○ Découpable		

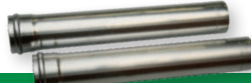

**TUBE - PARALLÈLE**

Description	SGE 40	SGE 60
Ø 100 L = 500 mm	0307160	0307160
Ø 100 L = 1000 mm	0307161	0307161
○ Ensemble de deux pièces		



**COUDE - CONCENTRIQUE**

Description	SGE 40	SGE 60
Ø 100 / 150 Coude 90°	0302502	0302502
Ø 100 / 150 Coude 45°	0311454	0311454



**COUDE - PARALLÈLE**

Description	SGE 40	SGE 60
Ø 100 Coude 45°	0310197	0310197



**COUDE - PARALLÈLE**

Description	SGE 40	SGE 60
Ø 100 Coude 87/90°	0307164	0307164



**PIÈCE EN T - CONCENTRIQUE**

Description	SGE 40	SGE 60
Ø 100 / 150	0305244	0305244



**ADAPTATEUR - CONC. DE CONC.**

Description	SGE 40	SGE 60
De à		
Ø 100 / 150 Ø 130 / 200	0306188	0306188



**ADAPTATEUR - PAR. DE CONC.**

Description	SGE 40	SGE 60
De à		
2 x Ø 100 1 x Ø 150	0307142	0307142



**ADAPTATEUR - PAR. DE PAR.**

Description	SGE 40	SGE 60
De à		
Ø 100 Ø 130	0307168	0307168



**ADAPTATEUR - CONC. DE PAR.**

Description	SGE 40	SGE 60
De à		
Ø 100 / 150 2 x Ø 100	0304204	0304204



**GRILLE DE PROTECTION AIR FRAIS**

Description	SGE 40	SGE 60
Ø 100 / 150	0304872	0304872



**TUBE CONC. AVEC GRAISSEUR DE MESURE**

Description	SGE 40	SGE 60
Ø 100 / 150	0303854	0303854



**COLLIER DE SERRAGE - PIÈCE EN Y AVEC TUBE**

Description	SGE 40	SGE 60
Ø 154	0304199	0304199



**COLLIER DE SERRAGE - TUBE AVEC TUBE**

Description	SGE 40	SGE 60
Ø 150	0302506	0302506



**KIT VENTOUSE MURAL - PARALLÈLE**

Description	SGE 40	SGE 60
Ø 100	0305039	0305039
Ø 150	0307178	0307178
○ Incl. plaques murales		

# Configuration ventouse SGS 28 / 30 / 50 / 60

Evacuation coaxiale murale

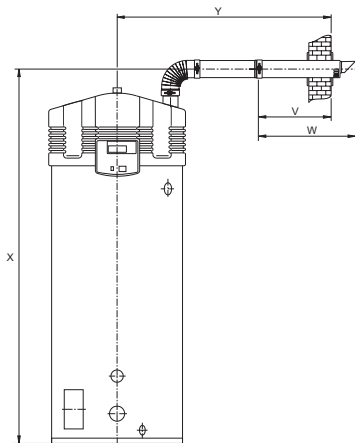

Configuration de la ventouse sortie murale

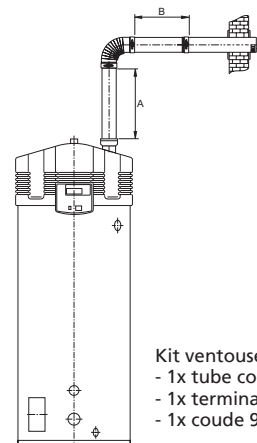

Kit ventouse mural (standard):  
 - 1x tube coaxial, 500 mm  
 - 1x terminal ventouse  
 - 1x coude 90°

	SGS 28	SGS 30	SGS 50	SGS 60
	Ø100/150	Ø100/150	Ø100/150	Ø100/150
V	550	550	550	550
W	790	790	790	790
X	1535	1535	1535	1535
Y	1480	1480	1480	1480
Y*	1030	1030	1030	1030

	SGS 28		SGS 30		SGS 50		SGS 60	
	min.	max.	min.	max.	min.	max.	min.	max.
A	0	40000	0	40000	0	40000	0	40000
B	0	40000	0	40000	0	40000	0	40000
A+B	<40000		<40000		<40000		<40000	
coudes	max. 7x45°/90°		max. 7x45°/90°		max. 7x45°/90°		max. 7x45°/90°	

- Dimensions en mm
- \* Distance sans tube concentrique entre coude et terminal mural

- Dimensions en mm

**Tuyau:**  
 Une inclinaison minimale de 5cm par mètre en horizontal en direction de l'appareil

Evacuation coaxiale toiture

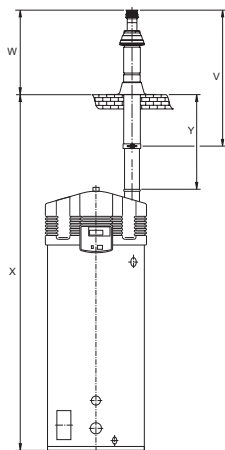

Configuration de la ventouse sortie toiture

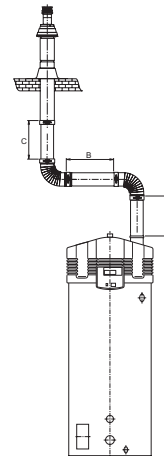

Kit ventouse toiture:  
 - 1x tube coaxial, 1000 mm  
 - 1x terminal ventouse  
 - 1x plaque toiture

	SGS 28	SGS 30	SGS 50	SGS 60
	Ø100/150	Ø100/150	Ø100/150	Ø100/150
V	1500	1500	1500	1500
W	1035	1035	1035	1035
X	2965	2965	2965	2965
X*	2015	2015	2015	2015
Y	1415	1415	1415	1415
Y*	465	465	465	465

	SGS 28		SGS 30		SGS 50		SGS 60	
	min.	max.	min.	max.	min.	max.	min.	max.
A	0	40000	0	40000	0	40000	0	40000
B	0	40000	0	40000	0	40000	0	40000
C	0	40000	0	40000	0	40000	0	40000
A+B+C	<40000		<40000		<40000		<40000	
coudes	max. 7x45°/90°		max. 7x45°/90°		max. 7x45°/90°		max. 7x45°/90°	

- Dimensions en mm
- \* Distance sans tube concentrique entre coude et terminal mural

- Dimensions en mm

**Tuyau:**  
 Une inclinaison minimale de 5cm par mètre en horizontal en direction de l'appareil

# Configuration ventouse SGS 80 / 100 / 120

## Evacuation coaxiale murale

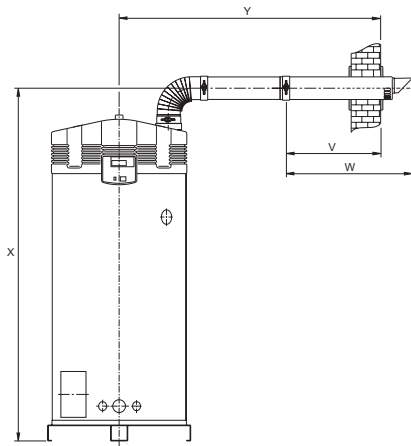

## Configuration de la ventouse sortie murale

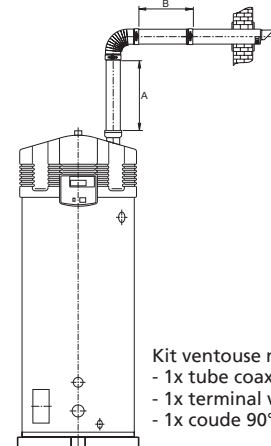

Kit ventouse mural (standard):  
 - 1x tube coaxial, 500 mm  
 - 1x terminal ventouse  
 - 1x coude 90°

	SGS 80	SGS 100	SGS 120
	Ø130/200	Ø130/200	Ø130/200
V	640	640	640
W	940	940	940
X	2230	2230	2230
Y	1620	1620	1620
Y*	1170	1170	1170

• Dimensions en mm  
 \* Distance sans tube concentrique entre coude et terminal mural

**Tuyau:**  
 Une inclinaison minimale de 5cm par mètre en horizontal en direction de l'appareil

	SGS 80		SGS 100		SGS 120	
	min.	max.	min.	max.	min.	max.
A	0	15000	0	15000	0	15000
B	0	15000	0	15000	0	15000
A+B	<15000		<15000		<15000	
coudes	max. 4x45°/90°		max. 4x45°/90°		max. 4x45°/90°	

• Dimensions en mm

## Evacuation coaxiale toiture

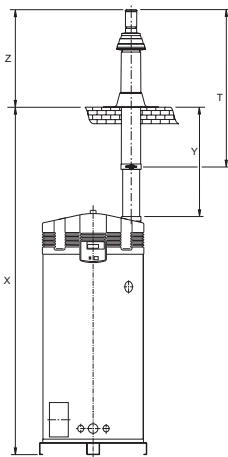

## Configuration de la ventouse sortie toiture

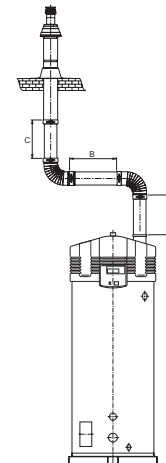

Kit ventouse toiture:  
 - 1x tube coaxial, 1000 mm  
 - 1x terminal ventouse  
 - 1x plaque toiture

	SGS 80	SGS 100	SGS 120
	Ø130/200	Ø130/200	Ø130/200
V	1730	1730	1730
W	1120	1120	1120
X	3620	3620	3620
X***	2670	2670	2670
Y	1560	1560	1560
Y***	610	610	610

• Dimensions en mm  
 \*\*\* Distance sans tube concentrique entre coude et terminal mural

**Tuyau:**  
 Une inclinaison minimale de 5cm par mètre en horizontal en direction de l'appareil

	SGS 80		SGS 100		SGS 120	
	min.	max.	min.	max.	min.	max.
A	0	15000	0	15000	0	15000
B	0	15000	0	15000	0	15000
C	0	15000	0	15000	0	15000
A+B+C	<15000		<15000		<15000	
coudes	max. 4x45°/90°		max. 4x45°/90°		max. 4x45°/90°	

• Dimensions en mm

# Conduits de fumée SGS catégorie B23 incl. art.no.

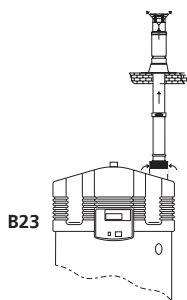

CATÉGORIE B23							
Description	SGS 28 Ø100/150	SGS 30 Ø100/150	SGS 50 Ø100/150	SGS 60 Ø100/150	SGS 80 Ø130/200	SGS 100 Ø130/200	SGS 120 Ø130/200
Grille de protection air frais	0304872	0304872	0304872	0304872	0307176	0307176	0307176
Terminal vertical	0305040	0305040	0305040	0305040	0307175	0307175	0307175
Plaque toiture	0307173	0307173	0307173	0307173	0307174	0307174	0307174

From september 1st 2009, the SGS 28 is standard equipped with Ø100/150. An adapter from Ø80/125 is available (Art. No. 0305009).

# Conduits de fumée SGS catégorie C13 incl. art.no.

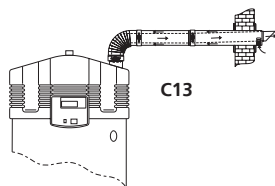

C13

CATÉGORIE C13							
Description	SGS 28 Ø100/150	SGS 30 Ø100/150	SGS 50 Ø100/150	SGS 60 Ø100/150	SGS 80 Ø130/200	SGS 100 Ø130/200	SGS 120 Ø130/200
Kit ventouse mural	0302504	0302504	0302504	0302504	0311465	0311465	0311465
Terminal mural *	0302505	0302505	0302505	0302505	0302313	0302313	0302313
Coude concentrique 45°	0311454	0311454	0311454	0311454	0311455	0311455	0311455
Coude concentrique 90°	0302502	0302502	0302502	0302502	0311456	0311456	0311456
Tube concentrique 500 mm	0302499	0302499	0302499	0302499	0302301	0302301	0302301
Tube concentrique 1000 mm	0311450	0311450	0311450	0311450	0311452	0311452	0311452
Tube concentrique 1500 mm	0311451	0311451	0311451	0311451	0311453	0311453	0311453
Collier de serrage Y-pièce	0302506(S)	0302506(S)	0302506(S)	0302506(S)	0302305(S)	0302305(S)	0302305(S)
Adaptateur concentrique	0306188 (Ø100/150 - Ø130/200)	0306188 (Ø100/150 - Ø130/200)	0306188 (Ø100/150 - Ø130/200)	0306188 (Ø100/150 - Ø130/200)	0306188 (Ø100/150 - Ø130/200)	0306188 (Ø100/150 - Ø130/200)	0306188 (Ø100/150 - Ø130/200)
Pièce de transformation concentrique / parallèle	0304204 (Ø100/150 - 2xØ100)	0304204 (Ø100/150 - 2xØ100)	0304204 (Ø100/150 - 2xØ100)	0304204 (Ø100/150 - 2xØ100)	0309605 (Ø130/200 - 2xØ130)	0309605 (Ø130/200 - 2xØ130)	0309605 (Ø130/200 - 2xØ130)
	0307135 (Ø100/150 - 2xØ130)	0307135 (Ø100/150 - 2xØ130)	0307135 (Ø100/150 - 2xØ130)	0307135 (Ø100/150 - 2xØ130)	-	-	-
Adaptateur parallèle/ concentrique	0307142 (2xØ100 - Ø100/150)	0307142 (2xØ100 - Ø100/150)	0307142 (2xØ100 - Ø100/150)	0307142 (2xØ100 - Ø100/150)	0306801 (2xØ130 - 1xØ200)	0306801 (2xØ130 - 1xØ200)	0306801 (2xØ130 - 1xØ200)
Tuyau concentrique avec graisseur de mesure	0303854 (Ø100/150)	0303854 (Ø100/150)	0303854 (Ø100/150)	0303854 (Ø100/150)	0303855 (Ø130/200)	0303855 (Ø130/200)	0303855 (Ø130/200)

\* incl. 2 plaques murales et collier de serrage.

# Conduits de fumée SGS catégorie C33 incl. art.no.

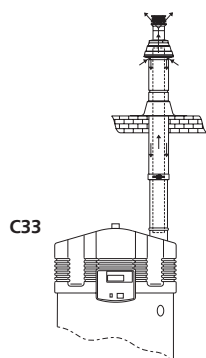

CATÉGORIE C33							
Description	SGS 28 Ø100/150	SGS 30 Ø100/150	SGS 50 Ø100/150	SGS 60 Ø100/150	SGS 80 Ø130/200	SGS 100 Ø130/200	SGS 120 Ø130/200
Kit ventouse toiture	0311463	0311463	0311463	0311463	0311464	0311464	0311464
Terminal vertical	0311458	0311458	0311458	0311458	0306390	0306390	0306390
Plaque toiture	0302509	0302509	0302509	0302509	0302328	0302328	0302328
Coude concentrique 45°	0311454	0311454	0311454	0311454	0311455	0311455	0311455
Coude concentrique 90°	0302502	0302502	0302502	0302502	0311456	0311456	0311456
Tube concentrique 500 mm	0302499	0302499	0302499	0302499	0302301	0302301	0302301
Tube concentrique 1000 mm	0311450	0311450	0311450	0311450	0311452	0311452	0311452
Tube concentrique 1500 mm	0311451	0311451	0311451	0311451	0311453	0311453	0311453
Collier de serrage Y-pièce	0302506(S)	0302506(S)	0302506(S)	0302506(S)	0302305(S)	0302305(S)	0302305(S)
Adaptateur concentrique	0306188 (Ø100/150 - Ø130/200)	0306188 (Ø100/150 - Ø130/200)	0306188 (Ø100/150 - Ø130/200)	0306188 (Ø100/150 - Ø130/200)	0306188 (Ø100/150 - Ø130/200)	0306188 (Ø100/150 - Ø130/200)	0306188 (Ø100/150 - Ø130/200)
Pièce de transformation concentrique / parallèle	0304204 (Ø100/150 - 2xØ100)	0304204 (Ø100/150 - 2xØ100)	0304204 (Ø100/150 - 2xØ100)	0304204 (Ø100/150 - 2xØ100)	0309605 (Ø130/200 - 2xØ130)	0309605 (Ø130/200 - 2xØ130)	0309605 (Ø130/200 - 2xØ130)
	0307135 (Ø100/150 - 2xØ130)	0307135 (Ø100/150 - 2xØ130)	0307135 (Ø100/150 - 2xØ130)	0307135 (Ø100/150 - 2xØ130)	-	-	-
Adaptateur parallèle/concentrique	0307142 (2xØ100 - Ø100/150)	0307142 (2xØ100 - Ø100/150)	0307142 (2xØ100 - Ø100/150)	0307142 (2xØ100 - Ø100/150)	0306801 (2xØ130 - 1xØ200)	0306801 (2xØ130 - 1xØ200)	0306801 (2xØ130 - 1xØ200)
Tuyau concentrique avec graisseur de mesure	0303854 (Ø100/150)	0303854 (Ø100/150)	0303854 (Ø100/150)	0303854 (Ø100/150)	0303855 (Ø130/200)	0303855 (Ø130/200)	0303855 (Ø130/200)

\* incl. 2 plaques murales et collier de serrage.

# Conduits de fumée SGS catégorie C53 incl. art.no.

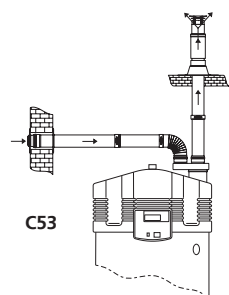

CATÉGORIE C53							
Description	SGS 28 Ø100/150	SGS 30 Ø100/150	SGS 50 Ø100/150	SGS 60 Ø100/150	SGS 80 Ø130/200	SGS 100 Ø130/200	SGS 120 Ø130/200
Terminal mural *	0305039 (Ø100)	0305039 (Ø100)	0305039 (Ø100)	0305039 (Ø100)	-	-	-
	0307178 (Ø130)	0307178 (Ø130)	0307178 (Ø130)	0307178 (Ø130)	0307178 (Ø130)	0307178 (Ø130)	0307178 (Ø130)
Terminal vertical	0305040 (Ø100)	0305040 (Ø100)	0305040 (Ø100)	0305040 (Ø100)	0307175 (Ø130)	0307175 (Ø130)	0307175 (Ø130)
Plaque toiture	0307173 (Ø100)	0307173 (Ø100)	0307173 (Ø100)	0307173 (Ø100)	0307174 (Ø160)	0307174 (Ø160)	0307174 (Ø160)
	0304204 (Ø100/150 - 2xØ100)	0304204 (Ø100/150 - 2xØ100)	0304204 (Ø100/150 - 2xØ100)	0304204 (Ø100/150 - 2xØ100)	-	-	-
Pièce de transformation concentrique / parallèle	0307135 (Ø100/150 - 2xØ130)	0307135 (Ø100/150 - 2xØ130)	0307135 (Ø100/150 - 2xØ130)	0307135 (Ø100/150 - 2xØ130)	0309605 (Ø130/200 - 2xØ130)	0309605 (Ø130/200 - 2xØ130)	0309605 (Ø130/200 - 2xØ130)

\* incl. 2 plaques murales.

From september 1st 2009, the SGS 28 is standard equipped with Ø100/150. An adapter from Ø80/125 is available (Art. No. 0305009).



# Conduits de fumée SGS



## KIT VENTOUSE VERTICAL - CONCENTRIQUE

Description	SGS 28	SGS 30	SGS 50	SGS 60	SGS 80	SGS 100	SGS 120
Ø 100 / 150	0311463	0311463	0311463	0311463	-	-	-
Ø 130 / 200	-	-	-	-	0311464	0311464	0311464

○ Incl. plaque et tube concentrique (1m)



## VENTOUSE VERTICAL - PARALLÈLE

Description	SGS 28	SGS 30	SGS 50	SGS 60	SGS 80	SGS 100	SGS 120
Ø 100	0305040	0305040	0305040	0305040	-	-	-
Ø 130	-	-	-	-	0307175	0307175	0307175



## PLAQUE TOITURE PARALLÈLE

Description	SGS 28	SGS 30	SGS 50	SGS 60	SGS 80	SGS 100	SGS 120
Terminal	Plaque						
Ø 100	Ø 120	0307173	0307173	0307173	0307173	-	-

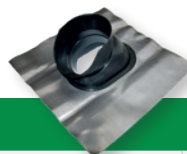

## PLAQUE TOITURE CONCENTRIQUE

Description	SGS 28	SGS 30	SGS 50	SGS 60	SGS 80	SGS 100	SGS 120
Ø 100 / 150	Coude 25°-45°	0306017	0306017	0306017	0306017	-	-
Ø 130 / 200	Coude 45°	-	-	-	-	0313847	0313847



## KIT VENTOUSE MURAL - CONCENTRIQUE

Description	SGS 28	SGS 30	SGS 50	SGS 60	SGS 80	SGS 100	SGS 120
Ø 100 / 150	0302504	0302504	0302504	0302504	-	-	-
Ø 130 / 200	-	-	-	-	0311465	0311465	0311465

○ Incl. tube (1m), coude concentrique (90°) et plaques murales



## PLAQUE TOITURE - CONCENTRIQUE

Description	SGS 28	SGS 30	SGS 50	SGS 60	SGS 80	SGS 100	SGS 120
Terminal	Plaque						
Ø 100/150	Ø 170	0302509	0302509	0302509	0302509	-	-
Ø 130/200	Ø 210	-	-	-	-	0302328	0302328

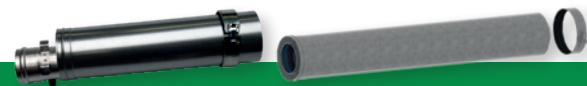

## TUBE - CONCENTRIQUE

Description	SGS 28	SGS 30	SGS 50	SGS 60	SGS 80	SGS 100	SGS 120
Ø 100 / 150 L = 500 mm	0302499	0302499	0302499	0302499	-	-	-
Ø 100 / 150 L = 1000 mm	0311450	0311450	0311450	0311450	-	-	-
Ø 100 / 150 L = 1500 mm	0311451	0311451	0311451	0311451	-	-	-
Ø 130 / 200 L = 500 mm	-	-	-	-	0302301	0302301	0302301
Ø 130 / 200 L = 1000 mm	-	-	-	-	0311452	0311452	0311452
Ø 130 / 200 L = 1500 mm	-	-	-	-	0311453	0311453	0311453

○ Découpable

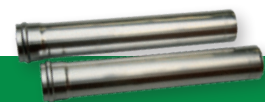

## TUBE - PARALLÈLE

Description	SGS 28	SGS 30	SGS 50	SGS 60	SGS 80	SGS 100	SGS 120
Ø 100 L = 500 mm	0307160	0307160	0307160	0307160	-	-	-
Ø 100 L = 1000 mm	0307161	0307161	0307161	0307161	-	-	-
Ø 130 L = 500 mm	-	-	-	-	0306804	0306804	0306804
Ø 130 L = 1000 mm	-	-	-	-	0306802	0306802	0306802

○ Ensemble de deux pièces



## COUDE - CONCENTRIQUE

Description	SGS 28	SGS 30	SGS 50	SGS 60	SGS 80	SGS 100	SGS 120
Ø 100 / 150 Coude 90°	0302502	0302502	0302502	0302502	-	-	-
Ø 100 / 150 Coude 45°	0311454	0311454	0311454	0311454	-	-	-
Ø 130 / 200 Coude 90°	-	-	-	-	0311456	0311456	0311456
Ø 130 / 200 Coude 45°	-	-	-	-	0311455	0311455	0311455



## KIT VENTOUSE MURAL - PARALLÈLE

Description	SGS 28	SGS 30	SGS 50	SGS 60	SGS 80	SGS 100	SGS 120
Ø 100	0305039	0305039	0305039	0305039	0305039	0305039	0305039
Ø 150	0307178	0307178	0307178	0307178	0307178	0307178	0307178

○ Incl. plaques murales

# Conduits de fumée SGS



## COUDE - PARALLÈLE

Description	SGS 28	SGS 30	SGS 50	SGS 60	SGS 80	SGS 100	SGS 120
Ø 100 Coude 45°	0310197	0310197	0310197	0310197	-	-	-
Ø 100 Coude 87/90°	0307164	0307164	0307164	0307164	-	-	-
Ø 130 Coude 87/90°	-	-	-	-	0306805	0306805	0306805
Ø 130 Coude 45°	-	-	-	-	0308026	0308026	0308026



## PIÈCE EN T - CONCENTRIQUE

Description	SGS 28	SGS 30	SGS 50	SGS 60	SGS 80	SGS 100	SGS 120
Ø 100 / 150	0305244	0305244	0305244	0305244	-	-	-



## GRILLE DE PROTECTION AIR FRAIS

Description	SGS 28	SGS 30	SGS 50	SGS 60	SGS 80	SGS 100	SGS 120
Ø 100 / 150	0304872	0304872	0304872	0304872	-	-	-
Ø 130 / 200	-	-	-	-	0307176	0307176	0307176



## ADAPTATEUR - CONC. DE PAR.

Description	SGS 28	SGS 30	SGS 50	SGS 60	SGS 80	SGS 100	SGS 120
De à							
Ø 100 / 150 2 x Ø 100	0304204	0304204	0304204	0304204	-	-	-
Ø 130 / 200 2 x Ø 130	-	-	-	-	0309605	0309605	0309605



## ADAPTATEUR - CONC. DE CONC.

Description	SGS 28	SGS 30	SGS 50	SGS 60	SGS 80	SGS 100	SGS 120
De à							
Ø 100 / 150 Ø 130 / 200	0306188	0306188	0306188	0306188	0306188	0306188	0306188

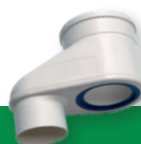

## ADAPTATEUR - PAR. DE CONC.

Description	SGS 28	SGS 30	SGS 50	SGS 60	SGS 80	SGS 100	SGS 120
De à							
2 x Ø 100 1 x Ø 150	0307142	0307142	0307142	0307142	-	-	-
2 x Ø 130 1 x Ø 200	-	-	-	-	0306801	0306801	0306801



## ADAPTATEUR - PAR. DE PAR.

Description	SGS 28	SGS 30	SGS 50	SGS 60	SGS 80	SGS 100	SGS 120
De à							
Ø 100 Ø 130	0307168	0307168	0307168	0307168	-	-	-
Ø 130 Ø 150	-	-	-	-	0307170	0307170	0307170



## TUBE CONC. AVEC GRAISSEUR DE MESURE

Description	SGS 28	SGS 30	SGS 50	SGS 60	SGS 80	SGS 100	SGS 120
Ø 100 / 150	0303854	0303854	0303854	0303854	-	-	-
Ø 130 / 200	-	-	-	-	0303855	0303855	0303855



## COLLIER DE SERRAGE - PIÈCE EN Y AVEC TUBE

Description	SGS 28	SGS 30	SGS 50	SGS 60	SGS 80	SGS 100	SGS 120
Ø156	0309632	0309632	0309632	0309632	-	-	-
Ø205	-	-	-	-	0309442	0309442	0309442



## COLLIER DE SERRAGE - TUBE AVEC TUBE

Description	SGS 28	SGS 30	SGS 50	SGS 60	SGS 80	SGS 100	SGS 120
Ø150	0302506(S)	0302506(S)	0302506(S)	0302506(S)	-	-	-
Ø200	-	-	-	-	0302305(S)	0302305(S)	0302305(S)

# Configuration ventouse TWI 35-130 / 45-190

Evacuation coaxiale murale

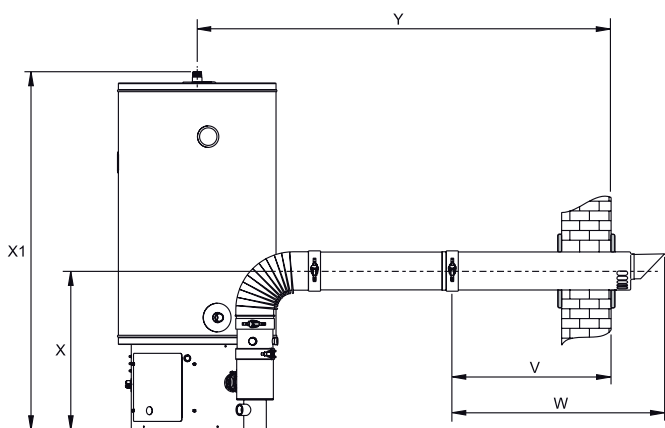

Configuration de cheminée sortie murale

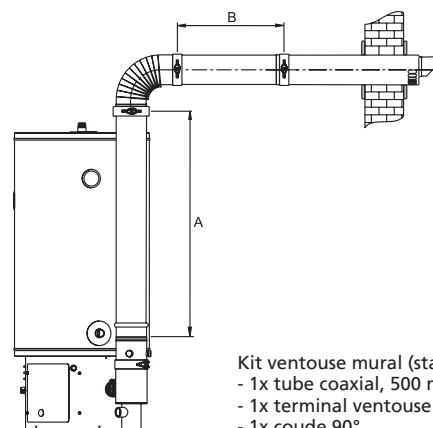

Kit ventouse mural (standard):  
 - 1x tube coaxial, 500 mm  
 - 1x terminal ventouse  
 - 1x coude 90°

	TWI 35-130	TWI 45-190
	Ø80/125	Ø80/125
V	550	550
W	725	725
X	530	530
X1	1270	1620
Y	1495	1495
Y*	1045	1045

• Dimensions en mm

\* Distance sans tube concentrique entre coude et terminal mural

**Tuyau:**

Une inclinaison minimale de 5cm par mètre en horizontal en direction de l'appareil

Evacuation coaxiale toiture

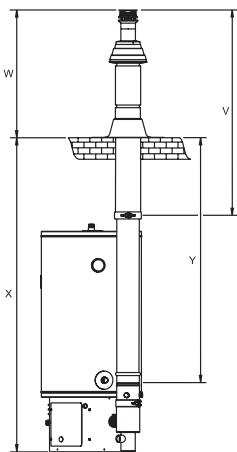

Configuration de cheminée sortie toiture

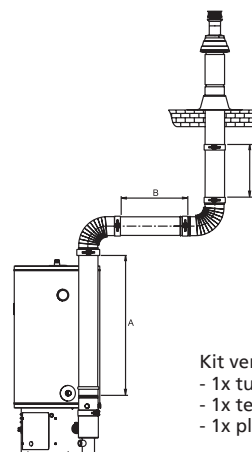

Kit ventouse toiture:  
 - 1x tube coaxial, 1000 mm  
 - 1x terminal ventouse  
 - 1x plaque toiture

	TWI 35-130	TWI 45-190
	Ø80/125	Ø80/125
V	1305	1305
W	680	680
X	1960	1960
Y*	1575	1575

• Dimensions en mm

\* Distance sans tube concentrique entre coude et terminal mural

**Tuyau:**

Une inclinaison minimale de 5cm par mètre en horizontal en direction de l'appareil

	TWI 35-130	TWI 45-190		
	min.	max.	min.	max.
A	0	20000	0	20000
B	0	20000	0	20000
C	0	20000	0	20000
A+B	<20000		<20000	
coudes	max. 5x45°/90°		max. 5x45°/90°	

• Dimensions en mm

# Conduits de fumée TWI catégorie B23 incl. art.no.

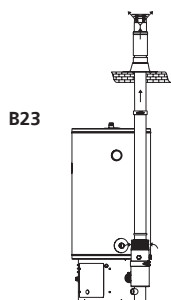

CATÉGORIE B23		
Description	TWI 35-130 Ø80/125	TWI 45-139 Ø80/125
Grille de protection air frais	0305030	0305030
Terminal vertical	0305041	0305041
Plaque toiture	0307172	0307172

# Conduits de fumée TWI catégorie C13 incl. art.no.

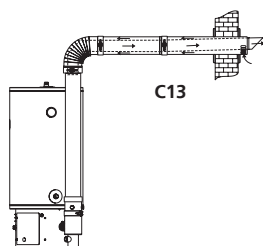

C13

CATÉGORIE C13		
Description	TWI 35-130 Ø80/125	TWI 45-139 Ø80/125
Kit ventouse mural	0302515	0302515
Terminal mural *	0302516	0302516
Coude concentrique 45°	0302514	0302514
Coude concentrique 90°	0313776	0313776
Tube concentrique 500 mm (découpable)	0302510	0302510
Tube concentrique 1000 mm (découpable)	0311448	0311448
Tube concentrique 1500 mm (découpable)	0311449	0311449
Collier de serrage Y-pièce	0302517(S)	0302517(S)
Adaptateur concentrique	0305009 (Ø80/125 - Ø100/150)	0305009 (Ø80/125 - Ø100/150)
	0305028 (Ø80/125 - 2xØ100)	0305028 (Ø80/125 - 2xØ100)
Pièce de transformation concentrique / parallèle	0305029 (Ø80/125 - 2xØ80)	0305029 (Ø80/125 - 2xØ80)
	0307177 (2xØ80 - Ø80/125)	0307177 (2xØ80 - Ø80/125)
Adaptateur parallèle/ concentrique	0307177 (2xØ80 - Ø80/125)	0307177 (2xØ80 - Ø80/125)
Tuyau concentrique avec graisseur de mesure	0303853	0303853

\* incl. 2 plaques murales et collier de serrage.

# Conduits de fumée TWI catégorie C33 incl. art.no.

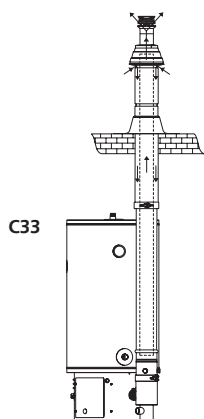

CATÉGORIE C33		
Description	TWI 35-130 Ø80/125	TWI 45-139 Ø80/125
Kit ventouse toiture	0305042	0305042
Terminal vertical	0304983	0304983
Plaque toiture	0302520	0302520
Coude concentrique 45°	0302514	0302514
Coude concentrique 90°	0313776	0313776
Tube concentrique 500 mm (découpable)	0302510	0302510
Tube concentrique 1000 mm (découpable)	0311448	0311448
Tube concentrique 1500 mm (découpable)	0311449	0311449
Collier de serrage Y-pièce	0302517(S)	0302517(S)
Adaptateur concentrique	0305009 (Ø80/125 - Ø100/150)	0305009 (Ø80/125 - Ø100/150)
Pièce de transformation concentrique / parallèle	0305028 (Ø80/125 - 2xØ100)	0305028 (Ø80/125 - 2xØ100)
	0305029 (Ø80/125 - 2xØ80)	0305029 (Ø80/125 - 2xØ80)
Adaptateur parallèle/concentrique	0307177 (2xØ80 - Ø80/125)	0307177 (2xØ80 - Ø80/125)
Tuyau concentrique avec graisseur de mesure	0303853	0303853

# Conduits de fumée TWI catégorie C53 incl. art.no.

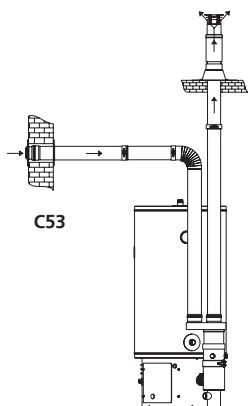

CATÉGORIE C53		
Description	TWI 35-130 Ø80/125	TWI 45-139 Ø80/125
Terminal mural *	0305016 (Ø80)	0305016 (Ø80)
	0305039 (Ø100)	0305039 (Ø100)
Terminal vertical	0305041 (Ø80)	0305041 (Ø80)
Plaque toiture	0305040 (Ø100)	0305040 (Ø100)
Pièce de transformation concentrique / parallèle	0307172 (Ø80)	0307172 (Ø80)
	0307173 (Ø100)	0307173 (Ø100)
Adaptateur parallèle	0305028 (Ø80/125 - 2xØ100)	0305028 (Ø80/125 - 2xØ100)
	0305029 (Ø80/125 - 2xØ80)	0305029 (Ø80/125 - 2xØ80)

\* incl. 2 plaques murales.

# Conduits de fumée TWI



**KIT VENTOUSE VERTICAL - CONCENTRIQUE**

Description	TWI 35-130	TWI 45-190
Ø 80 / 125	0305042	0305042

○ Incl. plaque et tube concentrique (1m)



**KIT VENTOUSE VERTICAL - PARALLÈLE**

Description	TWI 35-130	TWI 45-190
Ø 80	0305041	0305041

○ Incl. collier de serrage et ADAPTEUR



**PLAQUE TOITURE - CONCENTRIQUE**

Description	TWI 35-130	TWI 45-190
Terminal	Plaque	
Ø 80/125	Ø 140	
	0302520	0302520



**PLAQUE TOITURE PARALLÈLE**

Description	TWI 35-130	TWI 45-190
Terminal	Plaque	
Ø 80	Ø 110	
	0307172	0307172

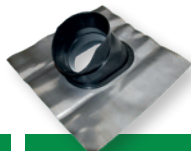

**PLAQUE TOITURE CONCENTRIQUE**

Description	TWI 35-130	TWI 45-190
Ø 80 / 125	Coude 25°-45°	
	0303506	0303506



**KIT VENTOUSE MURAL - CONCENTRIQUE**

Description	TWI 35-130	TWI 45-190
Ø 80 / 125	0302515	0302515

○ Incl. tube (0,5m), coude concentrique (90°) et plaques murales



**TUBE - CONCENTRIQUE**

Description	TWI 35-130	TWI 45-190
Ø 80 / 125	L = 500 mm	0302510*
Ø 80 / 125	L = 1000 mm	0311448*
Ø 80 / 125	L = 1500 mm	0311449*

\* Découpable

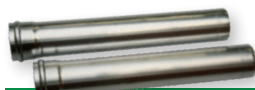

**TUBE - PARALLÈLE**

Description	TWI 35-130	TWI 45-190
Ø 80	L = 500 mm	0307179
Ø 80	L = 1000 mm	0307180
Ø 80	L = 1500 mm	0307181

○ Ensemble de deux pièces



**COUDE - CONCENTRIQUE**

Description	TWI 35-130	TWI 45-190
Ø 80 / 125	Coude 90°	0313776
Ø 80 / 125	Coude 45°	0302514



**COUDE - PARALLÈLE**

Description	TWI 35-130	TWI 45-190
Ø 80	Coude 87 / 90°	0307183
Ø 80	Coude 45°	0307182



**PIÈCE EN T - CONCENTRIQUE**

Description	TWI 35-130	TWI 45-190
Ø 80 / 125	0307487	0307487



**ADAPTEUR - CONC. DE PAR.**

Description	TWI 35-130	TWI 45-190
De	à	
Ø 80 / 125	2 x Ø 80	0305029



**ADAPTEUR - CONC. DE CONC.**

Description	TWI 35-130	TWI 45-190
De	à	
Ø 80 / 100	Ø 100 / 150	0305009



**ADAPTEUR - PAR. DE CONC.**

Description	TWI 35-130	TWI 45-190
De	à	
2 x Ø 80	1 x Ø 125	0307177



**ADAPTEUR - PAR. DE PAR.**

Description	TWI 35-130	TWI 45-190
De	à	
Ø 80	Ø 100	0307166



**GRILLE DE PROTECTION AIR FRAIS**

Description	TWI 35-130	TWI 45-190
Ø 80 / 100	0305030	0305030



**COLLIER DE SERRAGE - TUBE AVEC TUBE**

Description	TWI 35-130	TWI 45-190
Ø 125	0302517(S)	0302517(S)



**TUBE CONC. AVEC GRAISSEUR DE MESURE**

Description	TWI 35-130	TWI 45-190
Ø 80 / 125	0303853	0303853



# Conduits de fumée TWI II Système Concentric - Ø 80 / 125



**TERMINAL TOITURE**

Description	Art. No.	
	Alu	PP
Ø80/125	0311457	0310753



**TERMINAL MURALE**

Description	Art. No.	
	Alu	PP
Ø80/125	0302516	0310757



**KIT VENTOUSE VERTICAL**

Description	Art. No.	
	Alu	PP
Ø80/125	0305042	0310755

○ Incl. plaque et tube concentrique (1m)



**KIT VENTOUSE MURAL**

Description	Art. No.	
	Alu	PP
Ø80/125	0302515	0310759

○ Incl. tube (0,5m), coude concentrique (90°) et plaques murales

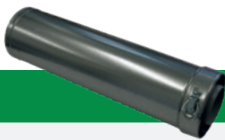

**TUYAU CONCENTRIQUE**

Description	Art. No.	
	Alu	PP
Ø80/125 250 mm	-	0310740
Ø80/125 500 mm	0302510*	-
Ø80/125 1000 mm	0311448*	0310742
Ø80/125 1500 mm	0311449*	-
Ø80/125 2000 mm	-	0310743
Ø80/125 Télésopique (280-395 mm)	-	0310744
Ø80/125 500 mm	-	0310745*

\* Découpable



**COUDES**

Description		Art. No.	
		Alu	PP
Ø80/125	90°	0313776	0310735
Ø80/125	45°	0302514	0310734



**PIÈCE EN T + OBTURATEUR**

Description	Art. Nr.	
	Alu	PP
Ø80/125	0307487	0310738



**PLAQUE MURALE (PP)**

Description	Art. No.
Ø125/150	0310761



**PLAQUE TOITURE**

Description		Art. No.
Terminal	Plaque	
Ø80/125	Ø140	0302520

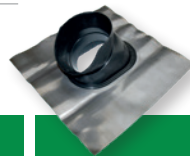

**PLAQUE TOITURE CONCENTRIQUE**

Description		Art. No.
Ø80/125	Coude 25°-45°	0303506



**GRILLE DE PROTECTION AIR FRAIS**

Description	Art. No.
Ø80/125	0305030

# Conduits de fumée TWI II Système Parallèle - 2 x Ø80



## TERMINAL TOITURE

Description	Art. No.
2 x Ø80	0310708

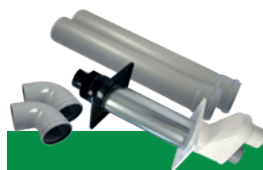

## KIT TERMINAL MURALE (PP)

Description	Art. No.
2 x Ø80	0310730

Incl. terminal murale, 2 coudes (90°) et 2 pièces



## KIT TERMINAL TOITURE (PP)

Description	Art. No.
2 x Ø80	0310712

Incl. terminal toiture, 2 tubes (1m) et plaque toiture



## VENTOUSE VERTICALE

Description	Art. No.
Ø 80	0305041

○ Incl. collier de serrage et adaptateur

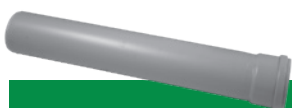

## TUBE

Description	Art. No.	
	Alu	PP
Ø80 250 mm	-	0310718
Ø80 500 mm	0307179	0310719
Ø80 1000 mm	0307180	0310720
Ø80 1500 mm	0307181	-
Ø80 2000 mm	-	0310721
Ø80 Télésopique	-	0310722



## COUDES (PP)

Description	Art. No.
Ø80 45°	0310701
Ø80 90°	0310702
Ø80 90° avec support	0310703



## COUDE



Description	Art. No.
Ø 80 Coude 45°	0307182
Ø 80 Coude 87 / 90°	0307183



## ADAPTATEUR - CONC. DE PAR.

Description	Art. No.
De Ø 80 / 125 à 2 x Ø 80	0312209

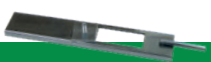

## SUPPORT POUR COUDE AVEC SUPPORT

Description	Art. No.
Ø80	0310690



## TERMINAL MURALE

Description	Art. No.	
	Alu	PP
2 x Ø80	0305016	0310728

# Configuration ventouse BFM 30 / 50 / 80

Evacuation coaxiale murale

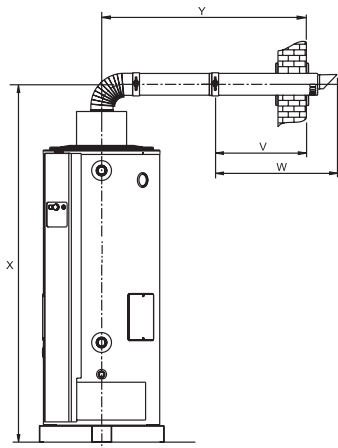

	BFM 30	BFM 50	BFM 80
	Ø80/125	Ø100/150	Ø130/200
V	550	550	550
W	725	790	940
X	2115	2165	2190
Y	1195	1215	1310
Y*	745	765	860

- Dimensions en mm
- \* Distance sans tube concentrique entre coude et terminal mural

Configuration de la ventouse sortie murale

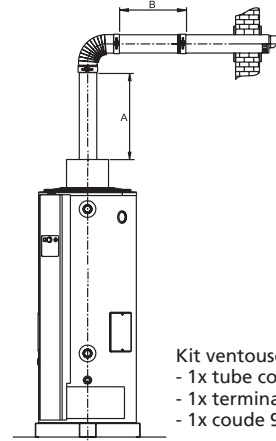

- Kit ventouse mural (standard):
- 1x tube coaxial, 500 mm
  - 1x terminal ventouse
  - 1x coude 90°

	BFM 30		BFM 50		BFM 80	
	min.	max.	min.	max.	min.	max.
A	0	7000	0	7000	0	7000
B	0	7000	0	7000	0	7000
A+B	<7000		<7000		<7000	
coudes	max. 2x45°/90°		max. 2x45°/90°		max. 2x45°/90°	

- Dimensions en mm

Evacuation coaxiale toiture

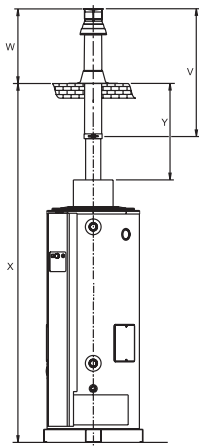

	BFM 30	BFM 50	BFM 80
	Ø80/125	Ø100/150	Ø130/200
V	1230	1310	1610
W	605	645	1000
X	3575	3615	3580
Y	1575	1615	1560
Y*	625	665	610

- Dimensions en mm
- \* Distance sans tube concentrique entre coude et terminal mural

Configuration de la ventouse sortie toiture

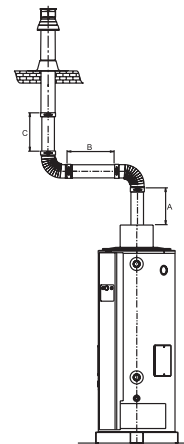

- Kit ventouse toiture:
- 1x tube coaxial, 1000 mm
  - 1x terminal ventouse
  - 1x plaque toiture

	BFM 30		BFM 50		BFM 80	
	min.	max.	min.	max.	min.	max.
A	0	7000	0	7000	0	7000
B	0	7000	0	7000	0	7000
C	0	7000	0	7000	0	7000
A+B+C	<7000		<7000		<7000	
coudes	max. 2x45°/90°		max. 2x45°/90°		max. 2x45°/90°	

- Dimensions en mm

# Configuration ventouse BFM 100 / 120

## Evacuation coaxiale murale

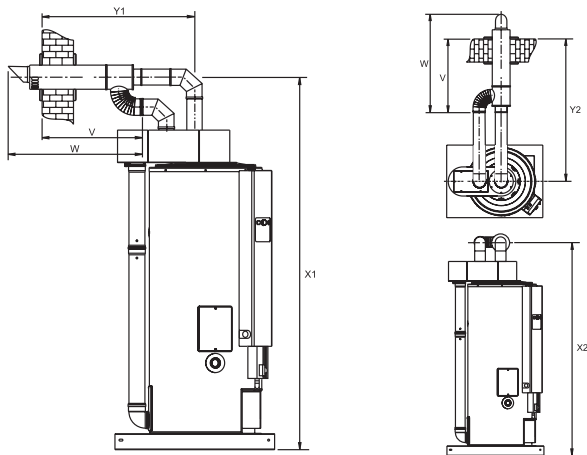

	BFM 100	BFM 120
	2x Ø130	2x Ø130
V	750	700
W	1050	1000
X1	2480	2480
Y1	1150	955
X2	2140	2140
Y2*	1250	870

• Dimensions en mm

\* Distance sans tube concentrique entre coude et terminal mural

## Configuration de la ventouse sortie murale

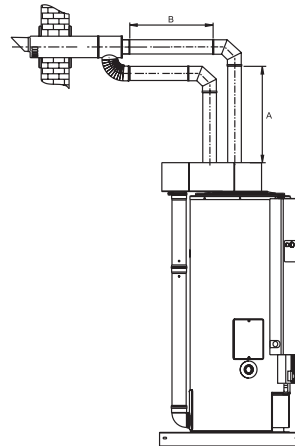

Kit ventouse mural (standard):

- 1x tube coaxial
- 2x rallonge, 500 mm
- 3x coude 90°

	BFM 100		BFM 120	
	min.	max.	min.	max.
A	0	7000	0	7000
B	0	7000	0	7000
A+B	<7000		<7000	
coudes	max. 2x45°/90°		max. 2x45°/90°	

• Dimensions en mm

## Evacuation coaxiale toiture

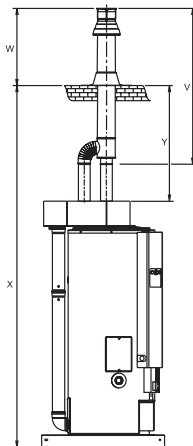

	BFM 100	BFM 120
	Ø130/200	Ø130/200
V	2560	2560
W	1000	1000
X	3580	3580
X*	2630	2630
Y	1560	1560
Y*	610	610

• Dimensions en mm

\* Distance sans tube concentrique entre coude et terminal mural

## Configuration de la ventouse sortie toiture

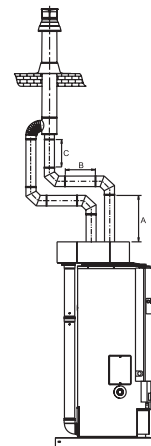

Kit ventouse toiture (standard):

- 1x tube coaxial
- 2x rallonge, 1000mm
- 1x coude 90°
- 1x plaque toiture

	BFM 100		BFM 120	
	min.	max.	min.	max.
A	0	7000	0	7000
B	0	7000	0	7000
C	0	7000	0	7000
A+B	<7000		<7000	
coudes	max. 2x45°/90°		max. 2x45°/90°	

• Dimensions en mm

# Conduits BFM catégorie C13 incl. art.no.

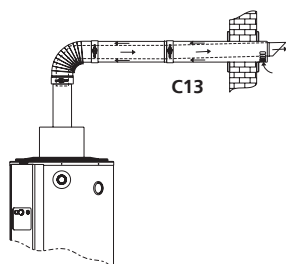

CATÉGORIE C13					
Description	BFM 30 Ø80/125	BFM 50 Ø100/150	BFM 80 Ø130/200	BFM 100 2x Ø130	BFM 120 2x Ø130
Kit ventouse mural	0302515	0302504	0311465	0306774	0306774
Terminal mural *	0302516	0302505	0302313	0306803	0306803
Coude concentrique 45°	0302514	0311454	0311455	0311455	0311455
Coude concentrique 90°	0313776	0302502	0311456	0311456	0311456
Coude 45°	0310197	0310197	0310197	0308026	0308026
Coude 90°	0307164	0307164	0307164	0306805	0306805
Tube concentrique 500 mm	0302510 (découpable)	0302499	0302301	N/A	N/A
Tube concentrique 1000 mm	0311448 (découpable)	0311450	0311452	N/A	N/A
Tube concentrique 1500 mm	0311449 (découpable)	0311451	0311453	N/A	N/A
Tube 500 mm	N/A	N/A	N/A	0306804	0306804
Tube 1000 mm	N/A	N/A	N/A	0306802	0306802
Tuyau concentrique avec graisseur de mesure	0303853	0303854	0303855	N/A	N/A

\* incl. 2 plaques murales et collier de serrage.

# Conduits de fumée BFM catégorie C33 incl. art.no.

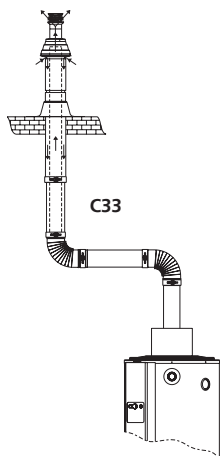

CATÉGORIE C33					
Description	BFM 30 Ø80/125	BFM 50 Ø100/150	BFM 80 Ø130/200	BFM 100 2x Ø130	BFM 120 2x Ø130
Kit ventouse toiture	0311459	0311463	0311464	0306773	0306773
Terminal vertical	0302519	0311458	0306390	0306800	0306800
Plaque toiture	0302520	0302509	0302328	0302328	0302328
Coude concentrique 45°	0302514	0311454	0311455	N/A	N/A
Coude concentrique 90°	0313776	0302502	0311456	N/A	N/A
Coude 45°	N/A	N/A	N/A	0308026	0308026
Coude 90°	N/A	N/A	N/A	0306805	0306805
Tube concentrique 500 mm	0302510 (découpable)	0302499	0302301	N/A	N/A
Tube concentrique 1000 mm	0311448 (découpable)	0311450	0311452	N/A	N/A
Tube concentrique 1500 mm	0311449 (découpable)	0311451	0311453	N/A	N/A
Tube 500 mm	N/A	N/A	N/A	0306804	0306804
Tube 1000 mm	N/A	N/A	N/A	0306802	0306802
Tuyau concentrique avec graisseur de mesure	0303853	0303854	0303855	N/A	N/A

\* incl. 2 plaques murales et collier de serrage.

# Conduits de fumée BFM



## KIT VENTOUSE VERTICAL - CONCENTRIQUE

Description	BFM 30	BFM 50	BFM 80	BFM 100	BFM 120
Ø 80 / 125	0311459	-	-	-	-
Ø 100 / 150	-	0311463	-	-	-
Ø 130 / 200	-	-	0311464	-	-
Ø 130 / 200	-	-	-	0306773*	0306773*

○ Incl. plaque et tube concentrique (1m)

\* 0306773 inclusif: ventouse concentrique et 2x tube parallèle (1m) et une ADAPTATEUR parallèle de concentrique



## PLAQUE TOITURE - CONCENTRIQUE

Description	BFM 30	BFM 50	BFM 80	BFM 100	BFM 120
Terminal	Plaque				
Ø 80 / 125	Ø 140	0302520	-	-	-
Ø 100 / 150	Ø 170	-	0302509	-	-
Ø 130 / 200	Ø 210	-	-	0302328	0302328

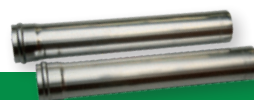

## TUBE - PARALLELE

Description	BFM 30	BFM 50	BFM 80	BFM 100	BFM 120
Ø 130 L = 500 mm	-	-	-	0306804	0306804
Ø 130 L = 1000 mm	-	-	-	0306802	0306802

○ Ensemble de deux pièces



## KIT VENTOUSE MURAL - CONCENTRIQUE

Description	BFM 30	BFM 50	BFM 80	BFM 100	BFM 120
Ø 80 / 125	0302515	-	-	-	-
Ø 100 / 150	-	0302504	-	-	-
Ø 130 / 200	-	-	0311465	-	-
Ø 130 / 200	-	-	-	0306774	0306774

○ Incl. tube (0,5m), coude concentrique (90°) et plaques murales



## COUDE - CONCENTRIQUE

Description	BFM 30	BFM 50	BFM 80	BFM 100	BFM 120
Ø 80 / 125 Coude 90°	0313776	-	-	-	-
Ø 80 / 125 Coude 45°	0302514	-	-	-	-
Ø 100 / 150 Coude 90°	-	0302502	-	-	-
Ø 100 / 150 Coude 45°	-	0311454	-	-	-
Ø 130 / 200 Coude 90°	-	-	0311456	-	-
Ø 130 / 200 Coude 45°	-	-	0311455	-	-



## TUBE - CONCENTRIQUE

Description	BFM 30	BFM 50	BFM 80
Ø 80 / 125 L = 500 mm	0302510*	-	-
Ø 80 / 125 L = 1000 mm	0311448*	-	-
Ø 80 / 125 L = 1500 mm	0311449*	-	-
Ø 100 / 150 L = 500 mm	-	0302499*	-
Ø 100 / 150 L = 1000 mm	-	0311450*	-
Ø 100 / 150 L = 1500 mm	-	0311451*	-
Ø 130 / 200 L = 500 mm	-	-	0302301*
Ø 130 / 200 L = 1000 mm	-	-	0311452*
Ø 130 / 200 L = 1500 mm	-	-	0311453*

\* Découpable

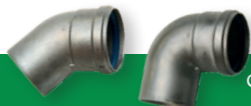

## COUDE - PARALLELE

Description	BFM 30	BFM 50	BFM 80	BFM 100	BFM 120
Ø 100 Coude 45°	0310197	0310197	0310197	-	-
Ø 100 Coude 87/90°	0307164	0307164	0307164	-	-
Ø 130 Coude 87/90°	-	-	-	0306805	0306805
Ø 130 Coude 45°	-	-	-	0308026	0308026



## T-TUBE - CONCENTRIC (AL)

Description	BFM 30	BFM 50	BFM 80	BFM 100	BFM 120
Ø 80 / 125	0307487	-	-	-	-
Ø 100 / 150	-	0305244	-	-	-
Ø 130 / 200	-	-	0307488	-	-



## ADAPTATEUR - CONC. DE PAR. (AL)

Description	BFM 30	BFM 50	BFM 80	BFM 100	BFM 120
van	naar				
Ø 130 / 200	1 x Ø 225	-	-	0306801	0306801



## COLLIER DE SERRAGE - TUBE AVEC TUBE (AL)

Description	BFM 30	BFM 50	BFM 80	BFM 100	BFM 120
Ø 125	0302517(S)	-	-	-	-
Ø 150	-	0302506(S)	-	-	-
Ø 200	-	-	0302305(S)	0302305(S)	0302305(S)



## PORTS DE MESURE - CONCENTRIC (AL)

Description	BFM 30	BFM 50	BFM 80
Ø 80 / 125	0303853	-	-
Ø 100 / 150	-	0303854	-
Ø 130 / 200	-	-	0303855

# Conduits de fumée

## MATÉRIEL STANDARD

Description	Art.no.
Rallonge Ø 80 mm 500 mm (2x)	0307179
Rallonge Ø 80 mm 1000 mm (2x)	0307180
Rallonge Ø 100 mm 500 mm (2x)	0307160
Rallonge Ø 100 mm 1000 mm (2x)	0307161
Rallonge Ø 130 mm 500 mm (2x)	0306804
Rallonge Ø 130 mm 1000 mm (2x)	0306802
Rallonge Ø 150 mm 500 mm (2x)	0307162
Rallonge Ø 150 mm 1000 mm (2x)	0307163
Coude 87/90° Ø 80 mm (2x)	0307183
Coude 87/90° Ø 100 mm (2x)	0307164
Coude 87/90° Ø 130 mm (2x)	0306805
Coude 87/90° Ø 150 mm (2x)	0307165
Adaptateur Ø 80/100	0307166
Adaptateur Ø 100/150 - Ø 80/125	0309660
Adaptateur Ø 100/80	0307167
Adaptateur Ø 100/130	0307168
Adaptateur Ø 130/100	0307169
Adaptateur Ø 130/150	0307170
Adaptateur Ø 150/130	0307171

## ACCESSOIRES

Description	Art.no.
Conc. Rallonge Ø 80/125 avec prise de mesure	0303853
Conc. Rallonge Ø 100/150 avec prise de mesure	0303854
Conc. Rallonge Ø 130/200 avec prise de mesure	0303855
Collier de serrage Ø 154 mm	0304199
Collier de serrage Ø 130 mm	0305027
Pièce en T concentrique 100/150 mm	0305244
Plaque toiture 100/150 mm	0306017
Adaptateur 100/150 à 130/200mm	0306188
Adaptateur concentrique 100/150 de parallèle 2x80	0309628



