

TWI before 30-04-'19

TWI parts



no	description	date	35-130	45-190
1	Thermostat sensor/ECO		6905055(S)	6905055(S)
2	Air pressure switch		3210679(S)	-
	Air proving switch G20		-	0324512(S)
	Air proving switch G30/31		-	0309343(S)
3	Fan MVL RG148		6903771(S)	-
3	Fan Ametek 150130-06		-	6903773(S)
4	Gasket fan		6903779(S)	6903779(S)
5	Burner		6903780(S)	6903780(S)
6	6 inch burner gasket		6903781(S)	6903781(S)
7	Igniter 201QM		6903768(S)	6903768(S)
8	Gas control		6903775(S)	6903775(S)
9	Red LED		6907307(S)	6907307(S)
10	Yellow LED		6907306(S)	6907306(S)
11	Green LED		6907305(S)	6907305(S)
12	Thermostat board		6903777(S)	6903777(S)
13	Burner control (1018-528)		-	3210536(S)
13	Burner control (1018-526)		3210457(S)	-
14	Transformer 120V-24V		6907302(S)	6907302(S)
15	Drain valve		6907316(S)	6907316(S)
16	Potentiowither		6905050(S)	6905050(S)
17	Fan insulation relais		4210293(S)	4210293(S)
18	Fuse holder		4210243(S)	4210243(S)
19	Fuse slow blow 2.5A		4210244(S)	4210244(S)
20	Transformer 230V-120V		4210300(S)	4210300(S)
21	Air supply hose		6903783(S)	6903783(S)
22	Air inlet hose		0308233(S)	0308233(S)
23	Cold water supply		6903778(S)	6903778(S)
24	Air inlet filter	after 06-03-'09	3710169(S)	3710169(S)
24	Air inlet filter kit	before 05-03-'09	0309344(S)	0309344(S)

TWI accessories

description	date	35-130	45-190
Gas cock ¾"		0300719(S)	0300719(S)
Protected cold supply setup G1"		0070066003(S)	0070066003(S)
T&P valve		0306755(S)	0306755(S)
Flow restrictor build in ¾" - 12 l/min		0309730(S)	0309730(S)
Flow restrictor build in ¾" - 10l/min		0309731(S)	0309731(S)
Flow restrictor build in ¾" - 8 l/min		0309732(S)	0309732(S)
Flow restrictor build in ¾" - 6 l/min		0309733(S)	0309733(S)

Exploded view TWI before 30-04-'19

EVD-0043

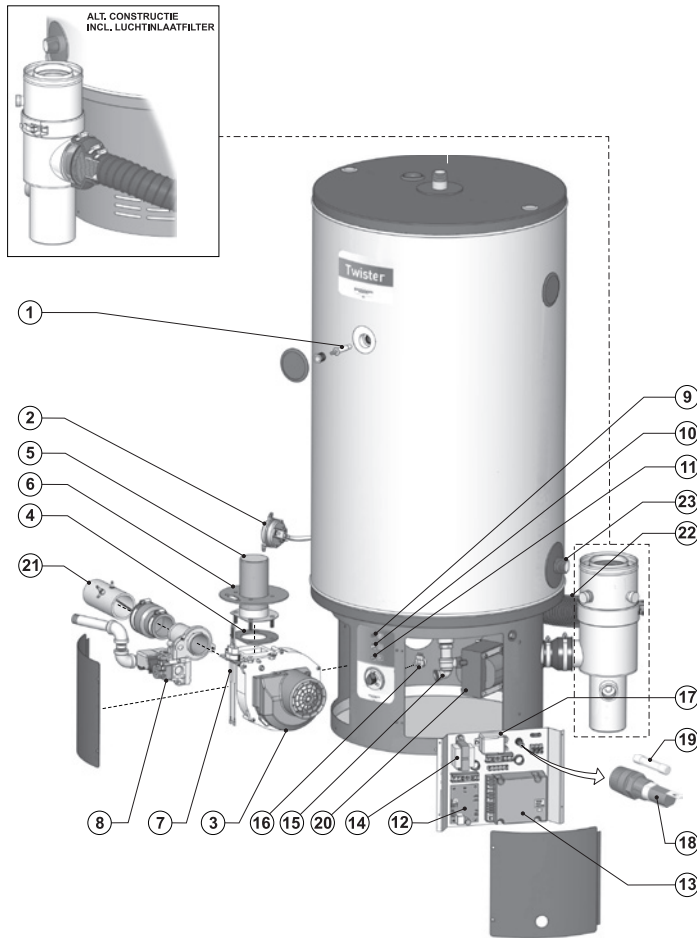

EVD-0049

