

Imperium™ controller

Installatie schema's



Model: IMP AWhA 01





Gegevens onderhevig aan verandering

A.O. Smith Europe

De Run 5305
PO Box 70
5500 AB Veldhoven
The Netherlands

T : +31 (0)40 294 2500
info@aosmith.com
www.aosmithinternational.com



Informatie over deze handleiding

Inhoud

Deze handleiding is opgesteld als ondersteuning voor de configuratie van de installatie van de Imperium controller. In dit document worden de verschillende configuraties omschreven welke beschikbaar zijn voor de Imperium controller.

In deze handleiding zijn 42 installatieschema's opgenomen die inzicht geven in de installatie en de componenten die er gebruikt zijn. Tevens wordt in elk schema de configuratiecode weergegeven.



Waarschuwing

De installatieschema's in deze handleiding dienen uitsluitend als richtlijn. Het uiteindelijke installatieontwerp en de keuze en dimensionering van leidingen en componenten moeten worden uitgevoerd volgens de algemene en lokaal geldende installatievoorschriften.

Voor meer informatie, raadpleeg de uitgebreide installatiehandleiding. Deze is beschikbaar op de website van A.O. Smith.

Doelgroep

De informatie in deze handleiding is van toepassing op twee doelgroepen:

- installateurs;
- service- en onderhoudsmonteurs.

Wijzigingen en technische verbeteringen voorgehouden.

Inhoudsopgave

Informatie over deze handleiding	1
Inhoudsopgave.....	2
1 Werking.....	4
1.1 Systeemwerking.....	4
1.2 Systeemletters en -nummers	4
1.3 Systeemcombinaties	5
1.4 Ondersteunde warmtepompen.....	6
1.5 Afkortingenlijst.....	6
2 Stroomschema	7
3 Systeemconfiguraties.....	8
3.1 DHW	8
3.2 Combi (DHW + CV).....	8
3.2 Combi (DHW + CV) (vervolg).....	9
3.3 CV	9
3.4 Legenda installatie schema's	10
A.1 DHW Systeem A1	12
A.2 DHW Systeem A2	13
A.3 DHW Systeem A3	14
A.4 DHW Systeem A4	15
A.5 DHW Systeem A5	16
A.6 DHW Systeem A6	17
A.7 DHW Systeem A7	18
A.8 DHW Systeem A8	19
B.1 Combi Systeem B1	20
B.2 Combi Systeem B2	21
B.3 Combi Systeem B3	22
B.4 Combi Systeem B4	23
B.5 Combi Systeem B5	24
B.6 Combi Systeem B6	25
B.7 Combi Systeem B7	26
B.8 Combi Systeem B8	27
C.1 Combi Systeem C1	28
C.2 Combi Systeem C2	29
C.3 Combi Systeem C3	30
C.4 Combi Systeem C4	31
C.5 Combi Systeem C5	32
C.6 Combi Systeem C6	33
C.7 Combi Systeem C7	34
C.8 Combi Systeem C8	35
D.1 Combi Systeem D1	36
D.2 Combi Systeem D2	37

D.3	Combi Systeem D3	38
D.4	Combi Systeem D4	39
D.5	Combi Systeem D5	40
D.6	Combi Systeem D6	41
D.7	Combi Systeem D7	42
D.8	Combi Systeem D8	43
E.1	Combi Systeem E1.....	44
E.2	Combi Systeem E2.....	45
E.3	Combi Systeem E3.....	46
E.4	Combi Systeem E4.....	47
E.5	Combi Systeem E5.....	48
E.6	Combi Systeem E6.....	49
E.7	Combi Systeem E7.....	50
E.8	Combi Systeem E8.....	51
F	CH Systeem F.....	52
G	CH Systeem G	53

1 Werking

1.1 Systeemwerking

De Imperium controller is een onderdeel van uw complete A.O. Smith warmwatersysteem. Dit complete systeem bestaat uit de controller, tapwater- en buffervaten, warmtepompen, circulatiepompen en omloop- en regelkleppen. Dit complete verwarmingssysteem kan ingericht zijn op (DHW) warm tapwaterbereiding, het warm water voor uw CV-systeem verzorgen of een combinatie van beide systemen voor zijn rekening nemen. Voor een uitgebreide uitleg van de Imperium controller, raadpleeg de installatiehandleiding. Deze is beschikbaar op de website van A.O. Smith.

1.2 Systeemletters en -nummers

Wanneer de Imperium controller voor de eerste keer wordt ingeschakeld, wordt de gebruiker gevraagd om een systeemcode van de installatie in te voeren. Deze code bestaat bij een (DHW) warm tapwatersysteem of een (Combi) combinatie van DHW en CV-systeem uit een systeemletter en een systeemnummer, bij een CV-systeem alleen uit een systeemletter.

Om te bepalen welke systeemconfiguratie u nodig heeft voor uw installatie kunt u gebruikmaken van het stroomschema (zie [2](#)).

Wanneer de systeemconfiguratie bekend is kunt u met behulp van de tabellen de desbetreffende installatietekening raadplegen (zie [3](#)).

1.3 Systemcombinaties

De warmtepompen zijn opgedeeld in één of twee verschillende cascades. De eerste cascade (CC01) kan een combisysteem zijn, dat wil zeggen dat de warmtepompen zowel ingezet kunnen worden voor de bereiding van warm tapwater als voor het verzorgen van warm water voor uw CV-systeem. De tweede cascade (CC02) is speciaal voor het verzorgen van warm water voor het CV-systeem.

De volgende systeemcombinaties zijn mogelijk:



CC01

CC02

Systeemletter	Aantal buffervaten [BT0x]	Aantal warmtepompen in DHW of Combi-cascade	Aantal warmtepompen in een aanvullende CV-cascade
A	-	1-3	-
B	1	1-3	-
C	1	1-3	1-7
D	2	1-3	-
E	2	1-3	1-7
F	1	-	1-7
G	2	-	1-7

De Imperium controller heeft een tweetal mogelijkheden tot het verwarmen van tapwater, te weten een one-pass en een multi-pass mogelijkheid. Op basis van het bij u geïnstalleerde systeem is multi-pass (MP) of een combinatiesysteem (MP+OP) van beide modi van toepassing.

De volgende systeemcombinaties zijn mogelijk:

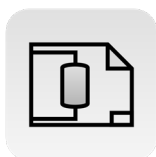

DHW systeemnummer	Aantal DHW voorraadvaten (ST0x)	Serie- of parallelstelling	One-pass (OP) of Multi-pass (MP)
1	1	-	MP + OP
2	1	-	MP
3	2	S	MP + OP
4	2	P	MP + OP
5	2	P	MP
6	3	S + 2P	MP + OP
7	3	P	MP + OP
8	3	P	MP

1.4 Ondersteunde warmtepompen

De Imperium besturing is alleen geschikt in combinatie met de onderstaande warmtepomp producten van A.O. Smith:

Type	Serie	Producten	ID-code
Lucht-water warmtepomp	Enevator Air Altus	AWHA 88	Altus 88
		AWHA 112	Altus 112

1.5 Afkortingenlijst

Afkorting	Omschrijving
AH	Booster verwarming
AI	Analoge ingang
AL	Alarmstatus
AO	Analoge uitgang
BH	Back-up verwarming
BMS	Gebouwen beheersysteem
BTxx	Buffervat
CCxx	Cascade
CH	Centrale verwarming (CV)
CL	Circulatie loop
CPxx	Circulatiepomp
CVxx	Omloopklep
CW	Koud water
DGxx	Ontgasser
DHW	Warm tapwater
DI	Digitale ingang
DO	Digitale uitgang
FTxx	Flow transmitter
HE	Warmtewisselaar
HPxx	Warmtepomp
HYS	Hysterese
MAX	Maximale waarde
MIN	Minimale waarde
MP	Verwarmen circulerend (Multi-pass)
NRV	Terugslagklep
OP	Verwarmen rechtstreeks (One-pass)
PI	PI controller
PTxx	Druk transmitter
RVxx	Regelklep
SP	Setpoint
STxx	Vorraadvat
TLxx	Transfer loop
TSxx	Temperatuursensor

2 Stroomschema

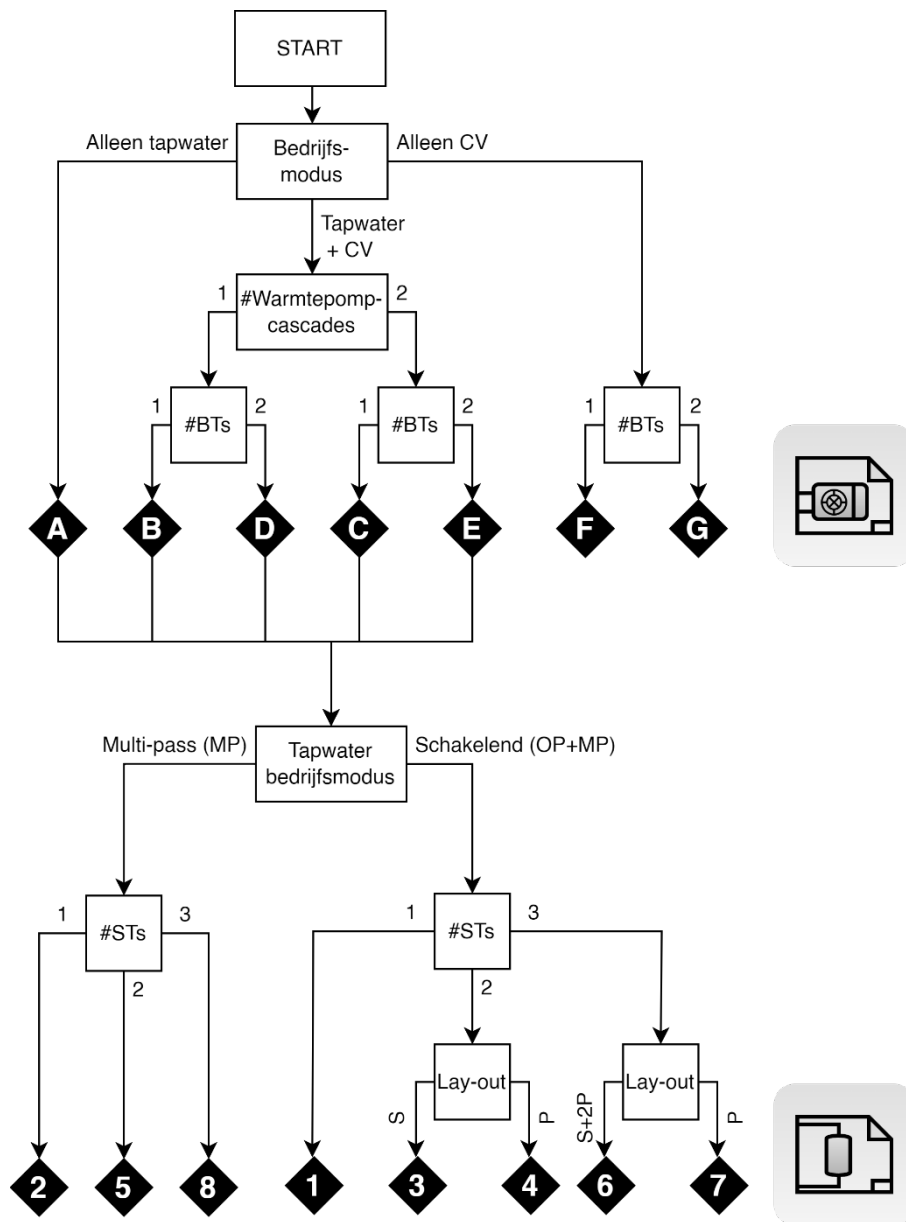

Afbeelding 1 Stroomschema om de installatiecode te bepalen

Legenda

#BTs Aantal buffervaten

#STs Aantal tapwatervaten

S Tapwatervaten in serie ($OP = ST01$, $MP = ST02$)

P Tapwatervaten parallel (*Tichelmann*)

S+2P Tapwatervaten in serie + parallel ($OP = ST01$, $MP = ST02 + ST03$)

3 Systeemconfiguraties

(Onderdelen in het groen weergegeven met een * zijn optioneel.)

3.1 DHW

Systeem	Aantal voorraadvaten	Aantal buffervaten	Serie- of parallel opstelling	One-pass of Multi-pass	Aantal warmtepomp-cascades
<u>A.1</u>	1	-	-	MP + OP	1
<u>A.2</u>	1	-	-	MP	1
<u>A.3</u>	2	-	S	MP + OP	1
<u>A.4</u>	2	-	P	MP + OP	1
<u>A.5</u>	2	-	P	MP	1
<u>A.6</u>	3	-	S / 2P	MP + OP	1
<u>A.7</u>	3	-	P	MP + OP	1
<u>A.8</u>	3	-	P	MP	1

3.2 Combi (DHW + CV)

Systeem	Aantal voorraadvaten	Aantal buffervaten	Serie- of parallel opstelling	One-pass of Multi-pass	Aantal warmtepomp-cascades
<u>B.1</u>	1	1	-	MP + OP	1
<u>B.2</u>	1	1	-	MP	1
<u>B.3</u>	2	1	S	MP + OP	1
<u>B.4</u>	2	1	P	MP + OP	1
<u>B.5</u>	2	1	P	MP	1
<u>B.6</u>	3	1	S / 2P	MP + OP	1
<u>B.7</u>	3	1	P	MP + OP	1
<u>B.8</u>	3	1	P	MP	1

Systeem	Aantal voorraadvaten	Aantal buffervaten	Serie- of parallel opstelling	One-pass of Multi-pass	Aantal warmtepomp-cascades
<u>C.1</u>	1	1	-	MP + OP	2
<u>C.2</u>	1	1	-	MP	2
<u>C.3</u>	2	1	S	MP + OP	2
<u>C.4</u>	2	1	P	MP + OP	2
<u>C.5</u>	2	1	P	MP	2
<u>C.6</u>	3	1	S / 2P	MP + OP	2
<u>C.7</u>	3	1	P	MP + OP	2
<u>C.8</u>	3	1	P	MP	2

3.2 Combi (DHW + CV) (vervolg)









System	Aantal voorraadvaten	Aantal buffervaten	Serie- of parallel opstelling	One-pass of Multi-pass	Aantal warmtepomp-cascades
<u>D.1</u>	1	2	-	MP + OP	1
<u>D.2</u>	1	2	-	MP	1
<u>D.3</u>	2	2	S	MP + OP	1
<u>D.4</u>	2	2	P	MP + OP	1
<u>D.5</u>	2	2	P	MP	1
<u>D.6</u>	3	2	S / 2P	MP + OP	1
<u>D.7</u>	3	2	P	MP + OP	1
<u>D.8</u>	3	2	P	MP	1





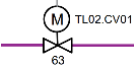

System	Aantal voorraadvaten	Aantal buffervaten	Serie- of parallel opstelling	One-pass of Multi-pass	Aantal warmtepomp-cascades
<u>E.1</u>	1	2	-	MP + OP	2
<u>E.2</u>	1	2	-	MP	2
<u>E.3</u>	2	2	S	MP + OP	2
<u>E.4</u>	2	2	P	MP + OP	2
<u>E.5</u>	2	2	P	MP	2
<u>E.6</u>	3	2	S / 2P	MP + OP	2
<u>E.7</u>	3	2	P	MP + OP	2
<u>E.8</u>	3	2	P	MP	2







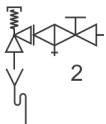



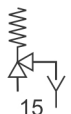

3.3 CV

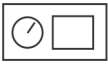
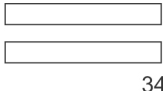
System	Aantal voorraadvaten	Aantal buffervaten	Serie- of parallel opstelling	One-pass of Multi-pass	Aantal warmtepomp-cascades
<u>F</u>	-	1	-	-	1
<u>G</u>	-	2	-	-	1

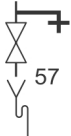
3.4 Legenda installatie schema's

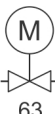
Kleur coderingen	
A 	Koud tapwaterleiding
B 	Warm tapwaterleiding
C 	Circulatieleiding
F 	Tapwaterdeel laadcircuit aanvoer (TL02)
G 	Tapwaterdeel laadcircuit retour (TL02)
	Warmtepomp laadcircuit aanvoer (TL01) / CV circuit aanvoer
	Warmtepomp laadcircuit retour (TL01) / CV circuit retour
XXX.XX *	Optionele accessoire geleverd door A.O. Smith (component is ook groen weergegeven)
	Component/accessoires geleverd door A.O. Smith (weergegeven in zwart)
	Component/accessoires niet geleverd door A.O. Smith (weergegeven in de betreffende leidingkleur)

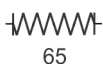
Componenten	
	Temperatuursensor
	Druktransmitter
	Flow transmitter
	Platenwarmtewisselaar
	Drukreducering
	Inlaatcombinatie
	(Service) afsluiters
	Terugslagklep

 <p>6</p>	Circulatiepomp tapwater (niet modulerend)
 <p>14</p>	Tappunt
 <p>15</p>	Overstortventiel
 <p>16</p>	Expansievat
 <p>22</p>	Verwarmingssysteem (CV)
 <p>33</p>	Kamerthermostaat
 <p>34</p>	Verdeler/verzamelaar
 <p>40</p>	Circulatiepomp tapwater (modulerend)
 <p>57</p>	Vul- en aftapkraan
 <p>61</p>	Inregelafsluiter met meetnippel
 <p>62</p>	Filter
 <p>63</p>	Omloopklep (open/dicht)
 <p>64</p>	Regelklep (modulerend)
 <p>65</p>	Flexibele leiding
 <p>66</p>	Motorgestuurde driewegklep

A.1 DHW System A1

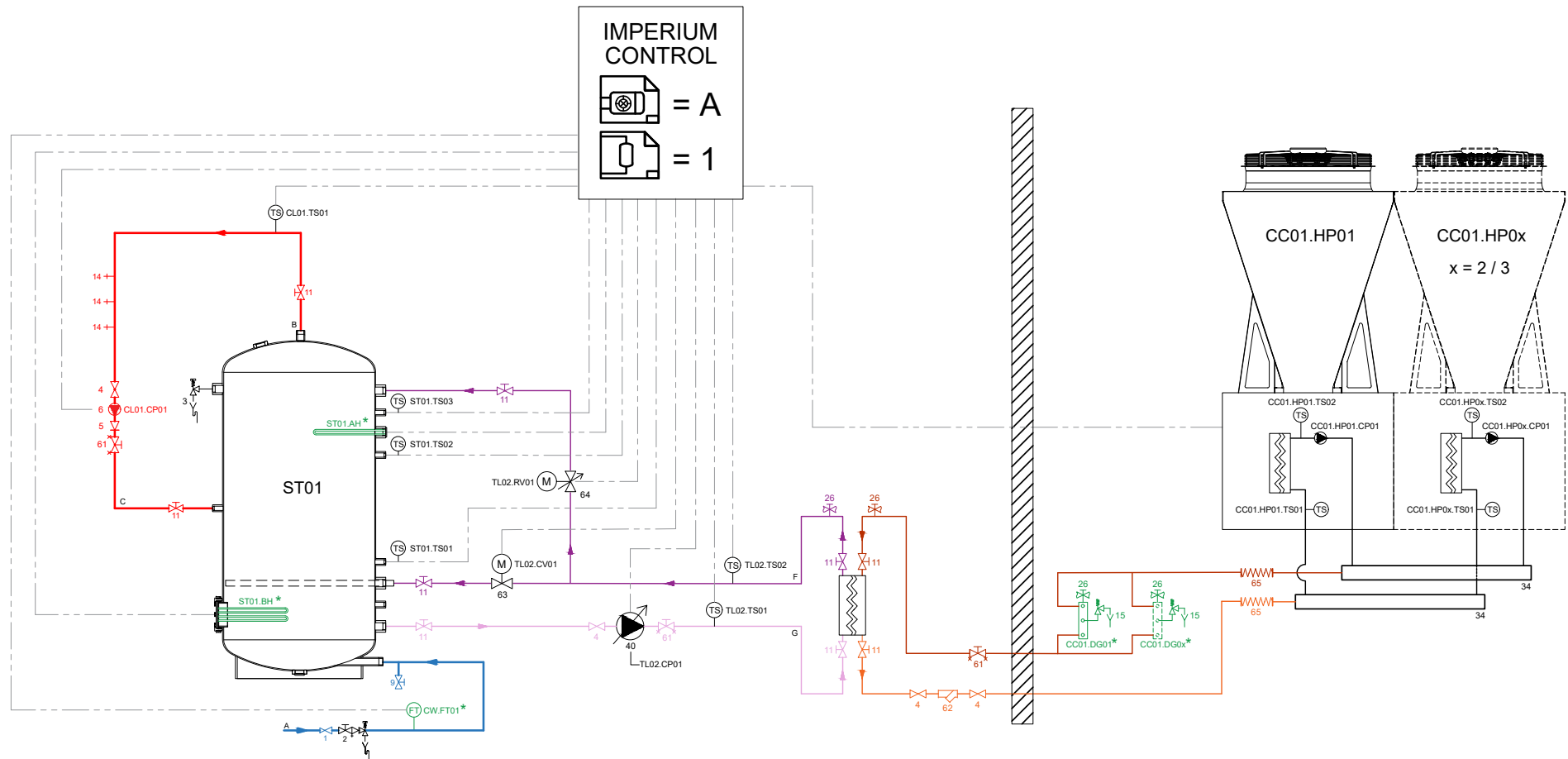

IMD-1527 R0 - IMPERIUM SYSTEM A1 (DHW) – 1 ST; MP+OP; 1 BANK

Terug naar [Systeemconfiguraties](#)



A.2 DHW System A2

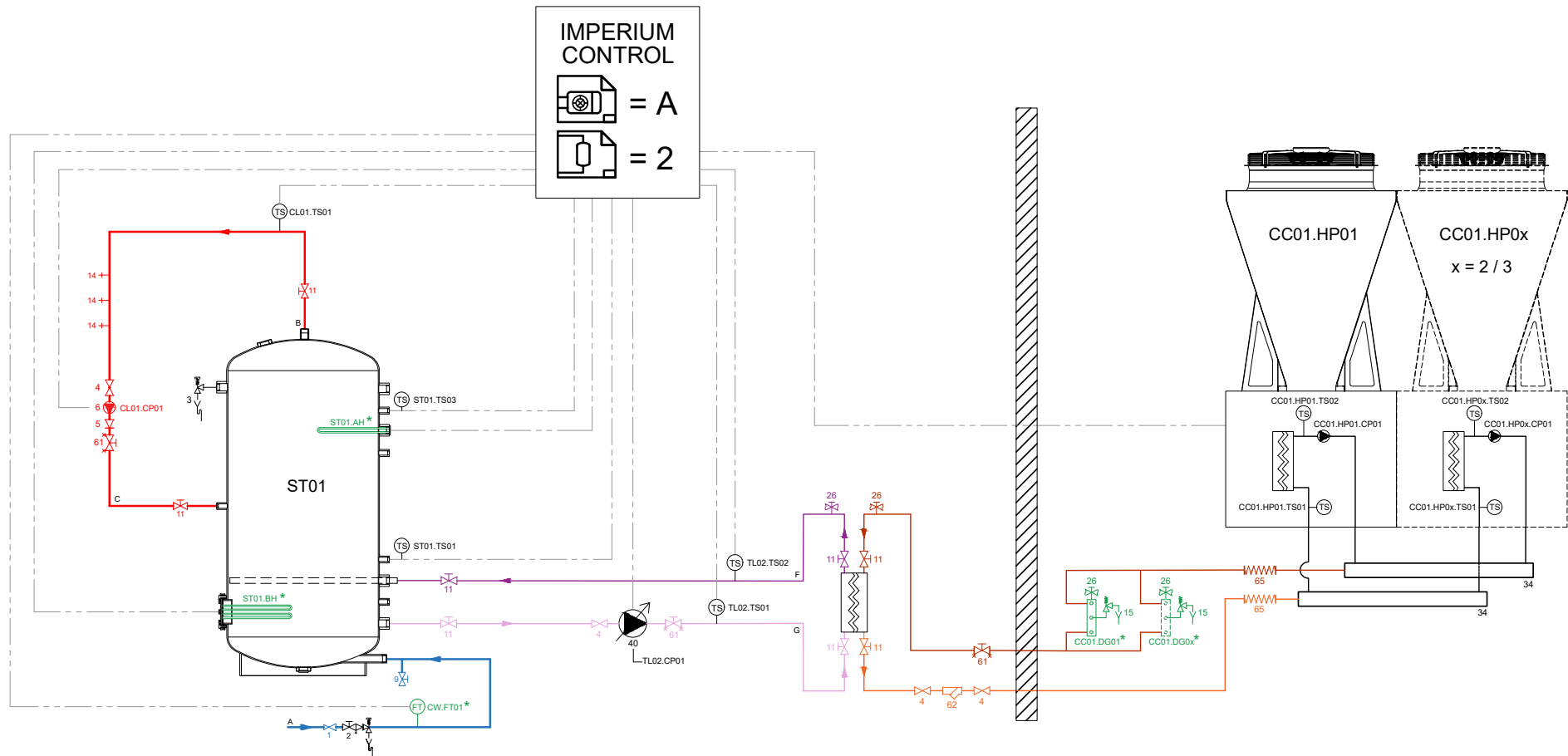

IMD-1525 R0 - IMPERIUM SYSTEM A2 (DHW) – 1 ST; MP; 1 BANK

Terug naar [Systeemconfiguraties](#)



A.3 DHW System A3

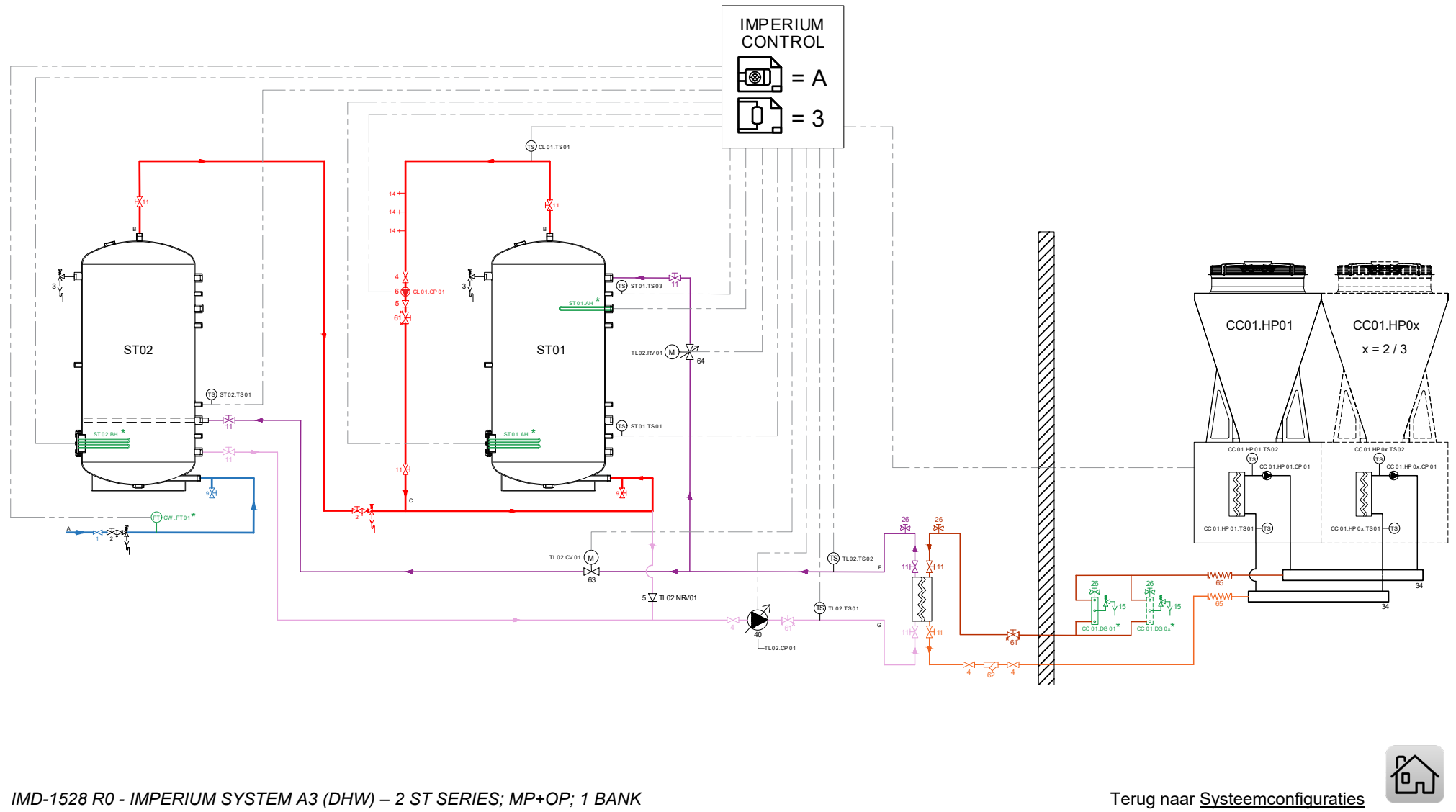

IMD-1528 R0 - IMPERIUM SYSTEM A3 (DHW) – 2 ST SERIES; MP+OP; 1 BANK

Terug naar [Systeemconfiguraties](#)



A.4 DHW System A4

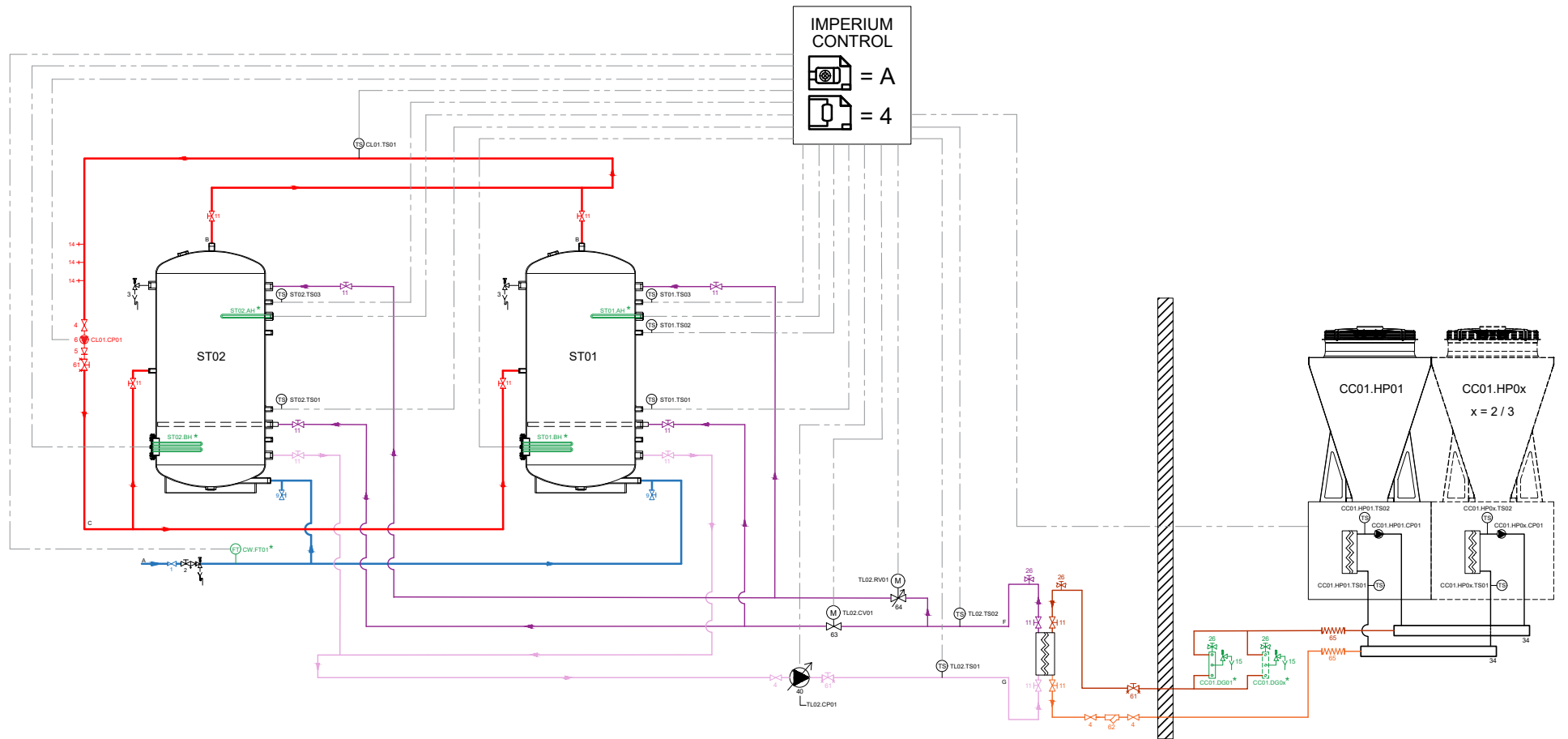

IMD-1537 R0 - IMPERIUM SYSTEM A4 (DHW) – 2 ST PARALLEL; MP+OP; 1 BANK

Terug naar [Systeemconfiguraties](#)



A.5 DHW System A5

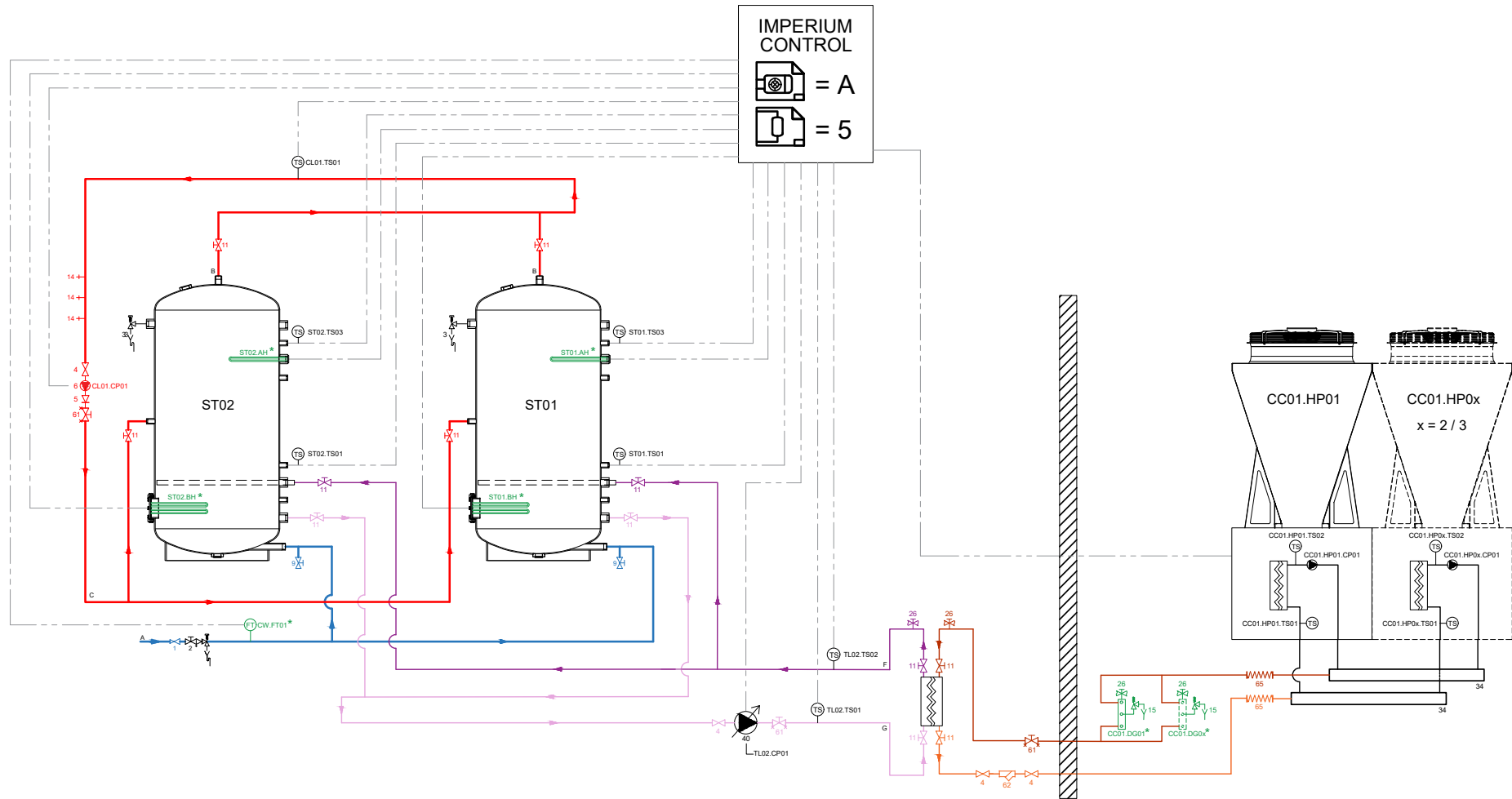

IMD-1538 R0 - IMPERIUM SYSTEM A5 (DHW) – 2 ST PARALLEL; MP; 1 BANK

Terug naar [Systeemconfiguraties](#)



A.6 DHW System A6

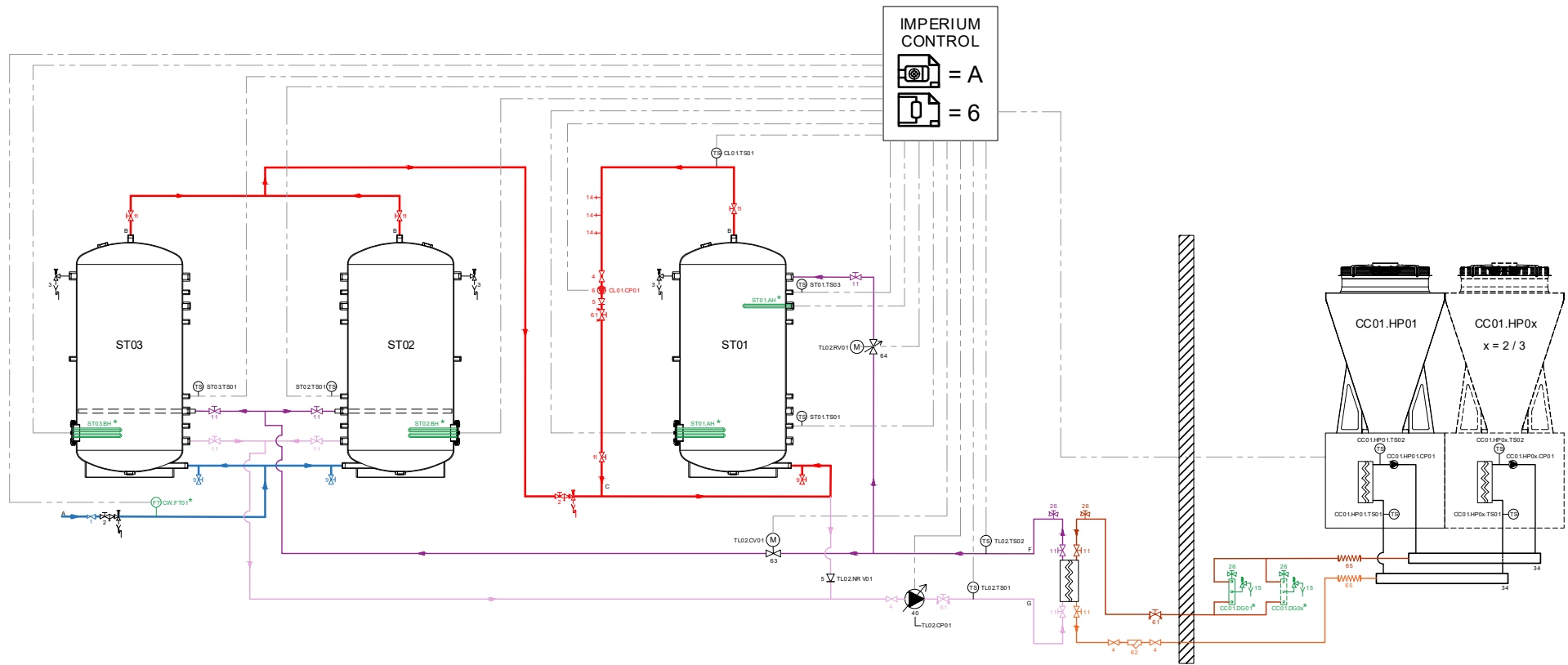

IMD-1539 R0 - IMPERIUM SYSTEM A6 (DHW) – 3 ST PARALLEL + SERIES; MP+OP; 1 BANK

Terug naar [Systeemconfiguraties](#)



A.7 DHW System A7

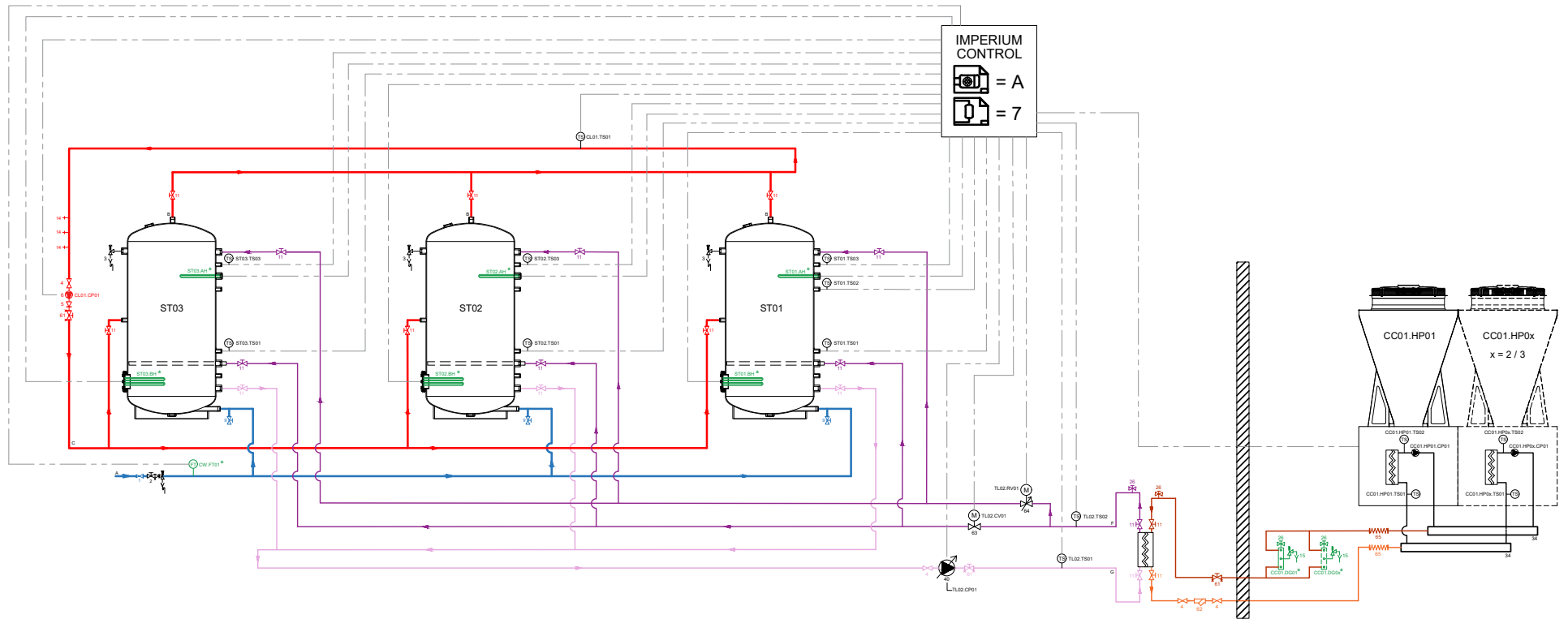

IMD-1540 R0 - IMPERIUM SYSTEM A7 (DHW) – 3 ST PARALLEL; MP+OP; 1 BANK

Terug naar [Systeemconfiguraties](#)



A.8 DHW System A8

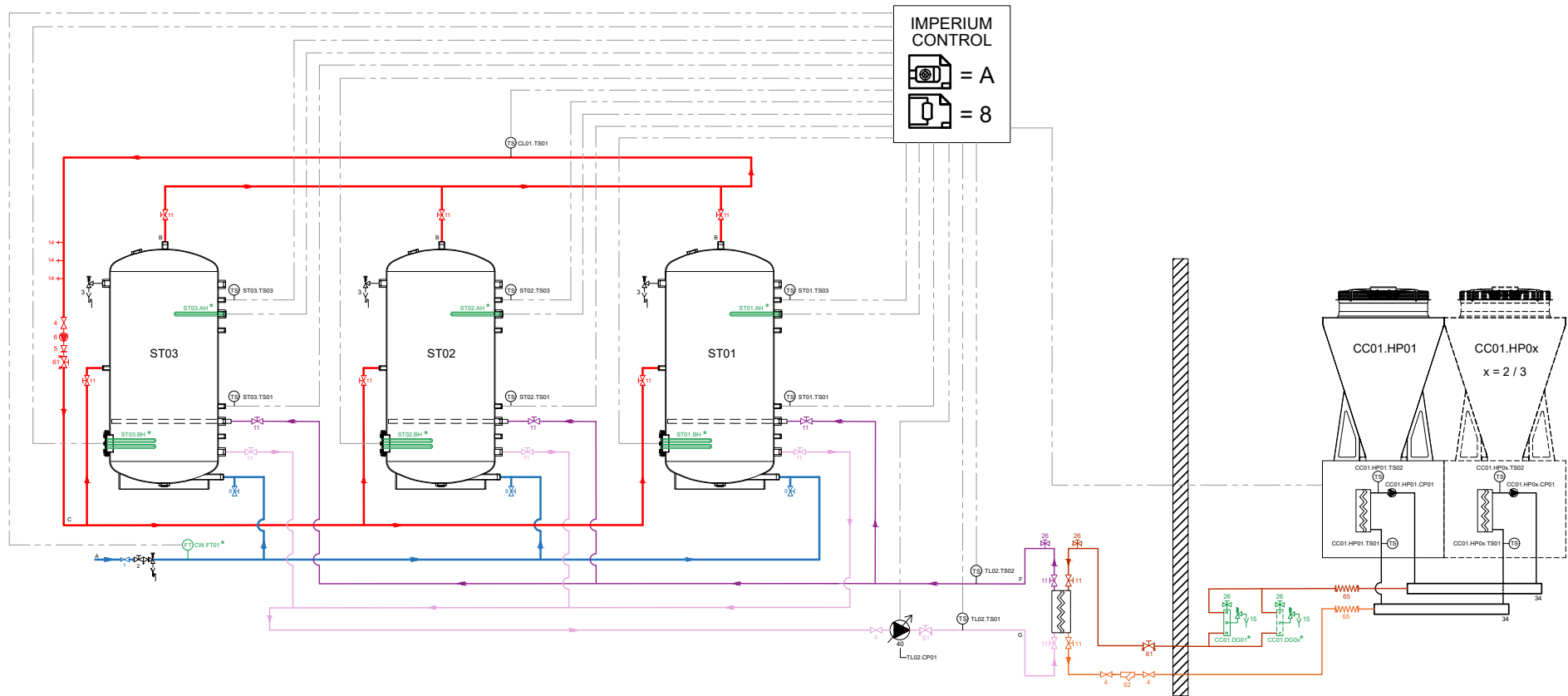

IMD-1541 R0 - IMPERIUM SYSTEM A8 (DHW) – 3 ST PARALLEL; MP; 1 BANK

Terug naar [Systeemconfiguraties](#)



B.1 Combi System B1

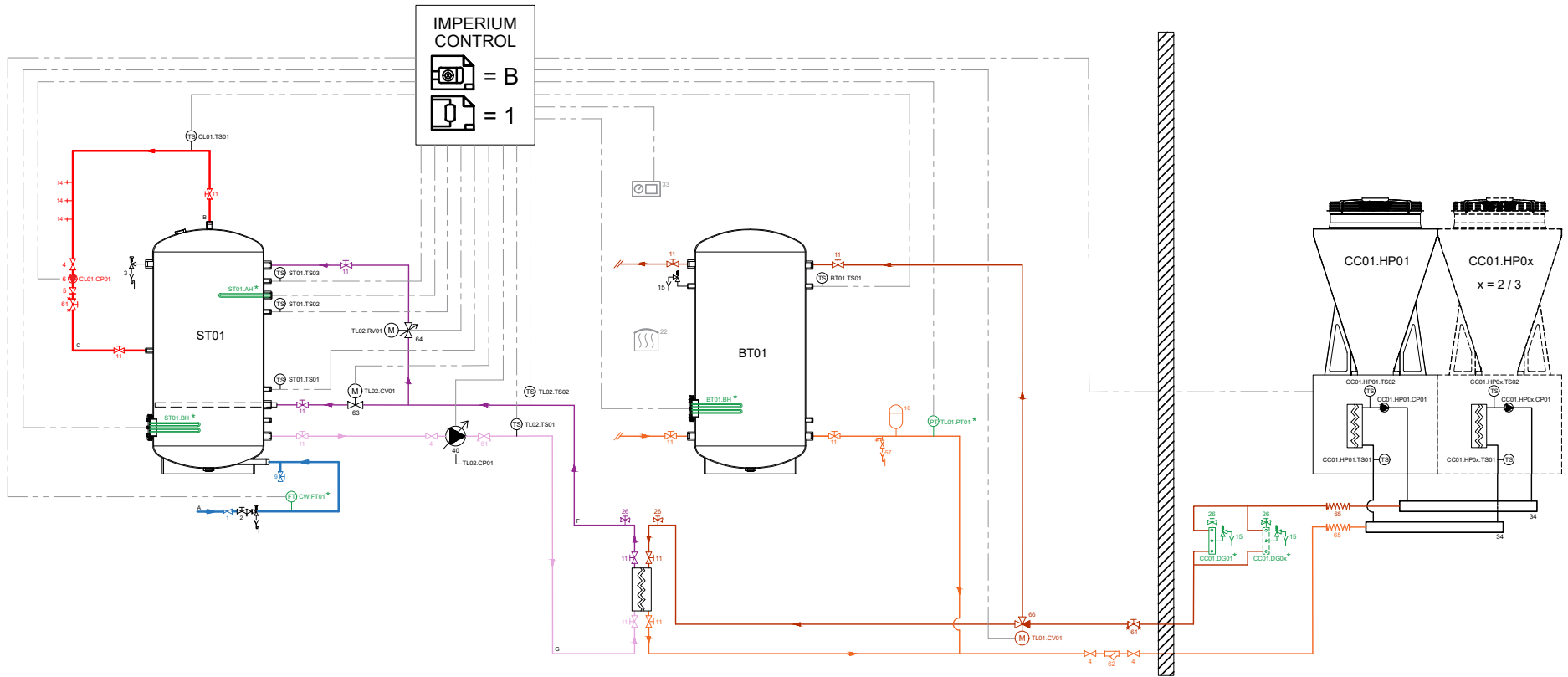

IMD-1523 R0 - IMPERIUM SYSTEM B1 (COMBI) – 1 ST; MP+OP; 1 BT; 1 BANK

Terug naar [Systeemconfiguraties](#)



B.2 Combi System B2

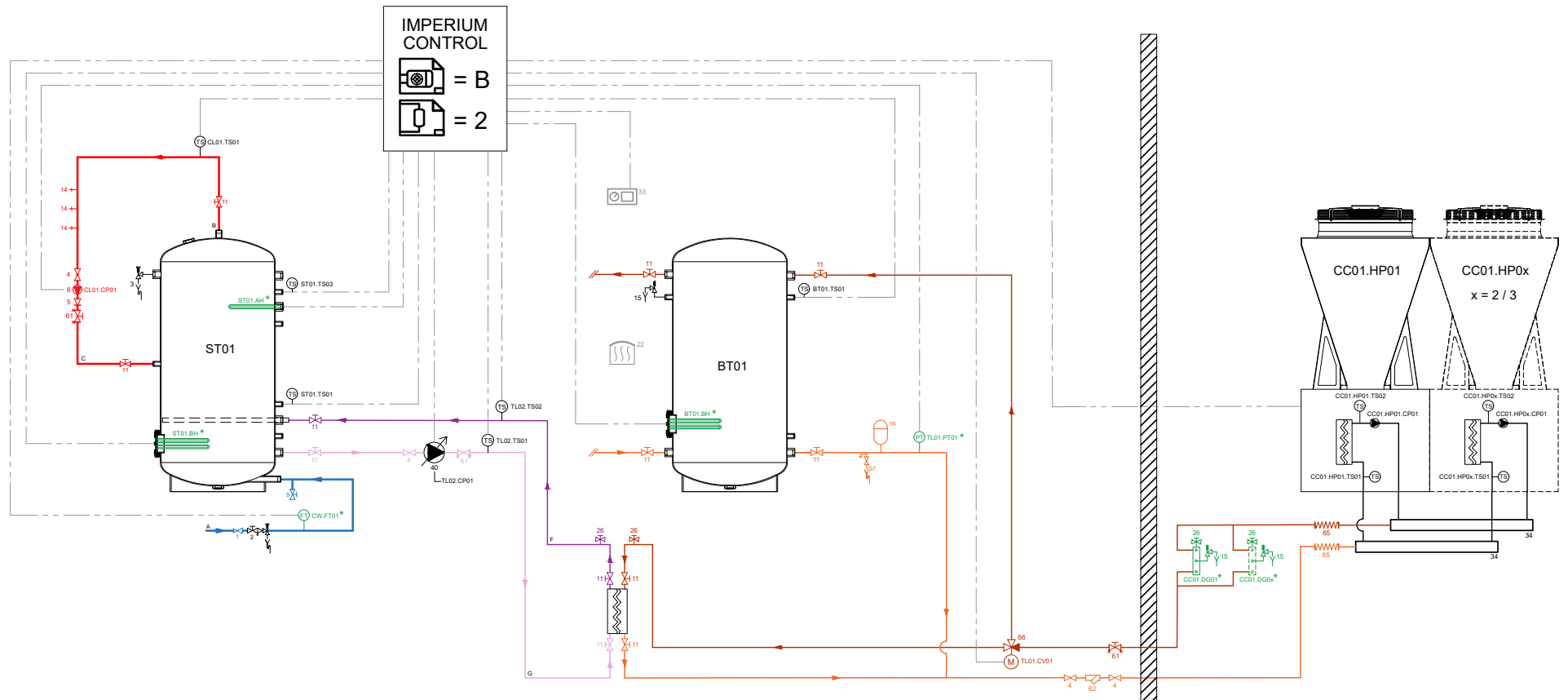

IMD-1549 R0 - IMPERIUM SYSTEM B2 (COMBI) – 1 ST; MP; 1 BT; 1 BANK

Terug naar [Systeemconfiguraties](#)



B.4 Combi System B4

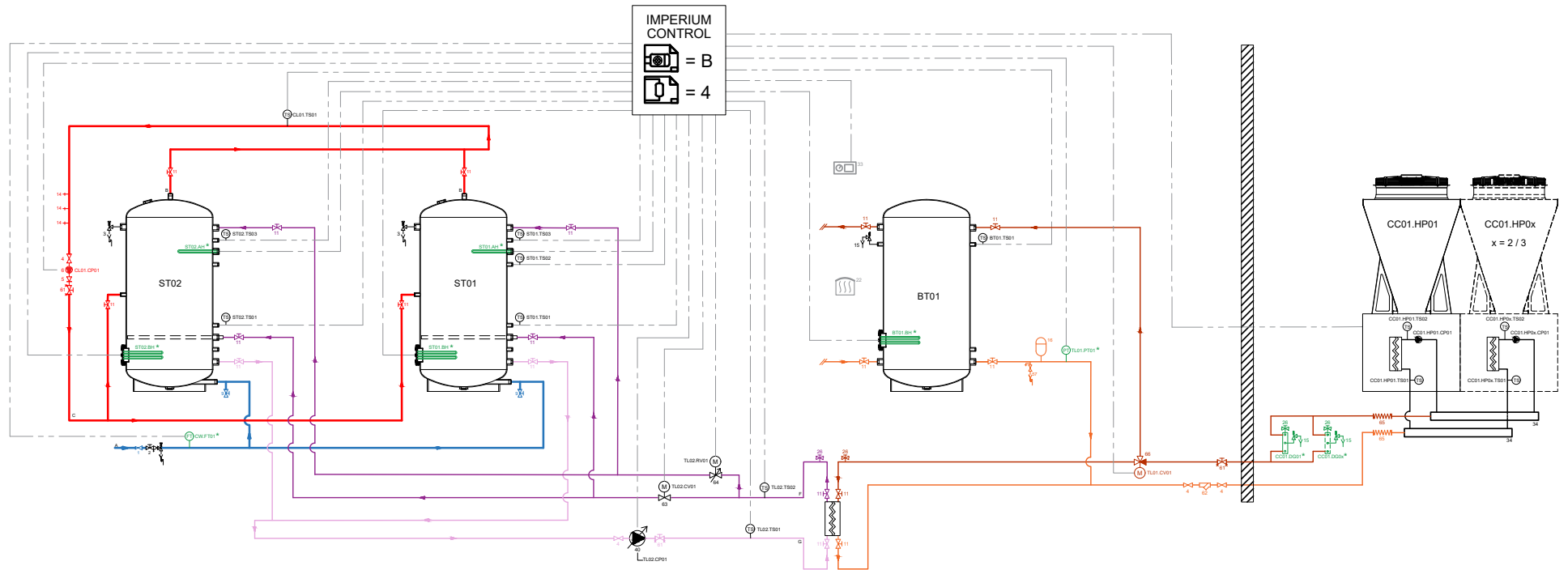

IMD-1557 R0 - IMPERIUM SYSTEM B4 (COMBI) – 2 ST PARALLEL; MP+OP; 1 BT; 1 BANK

Terug naar [Systeemconfiguraties](#)



B.5 Combi System B5

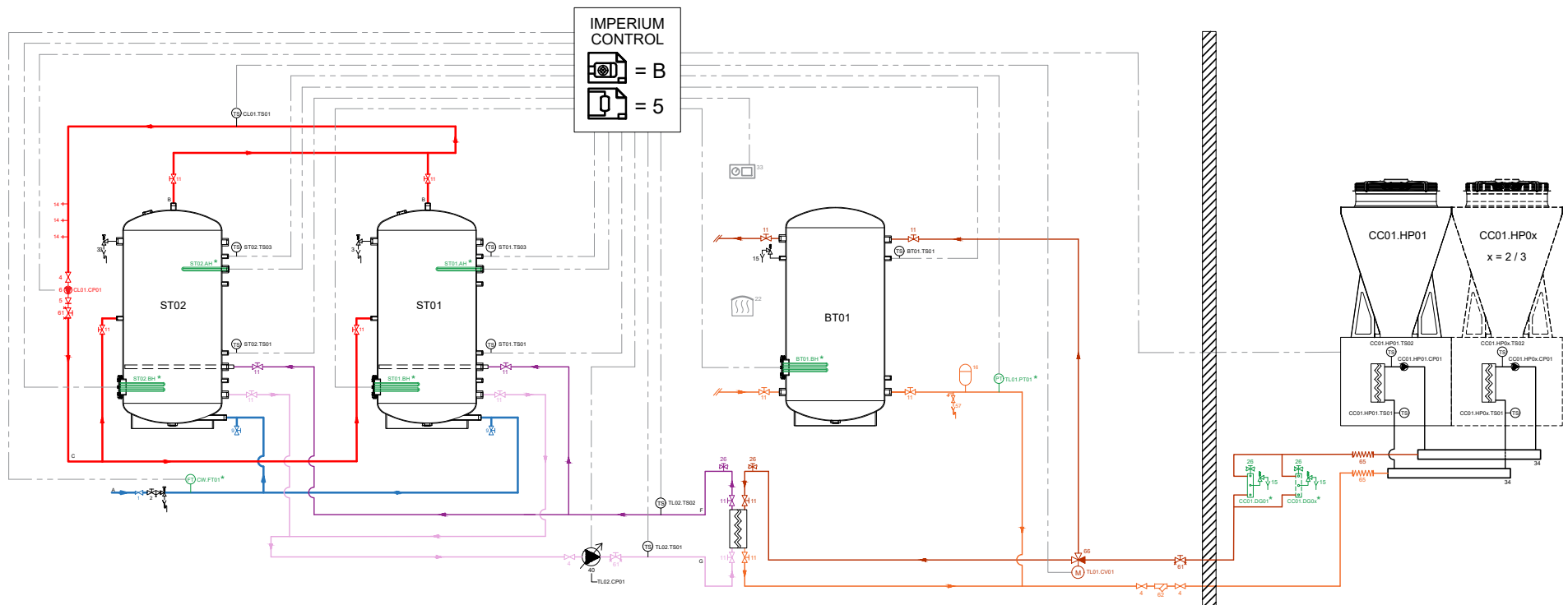

IMD-1524 R0 - IMPERIUM SYSTEM B5 (COMBI) – 2 ST PARALLEL; MP; 1 BT; 1 BANK

Terug naar [Systeemconfiguraties](#)



B.6 Combi System B6

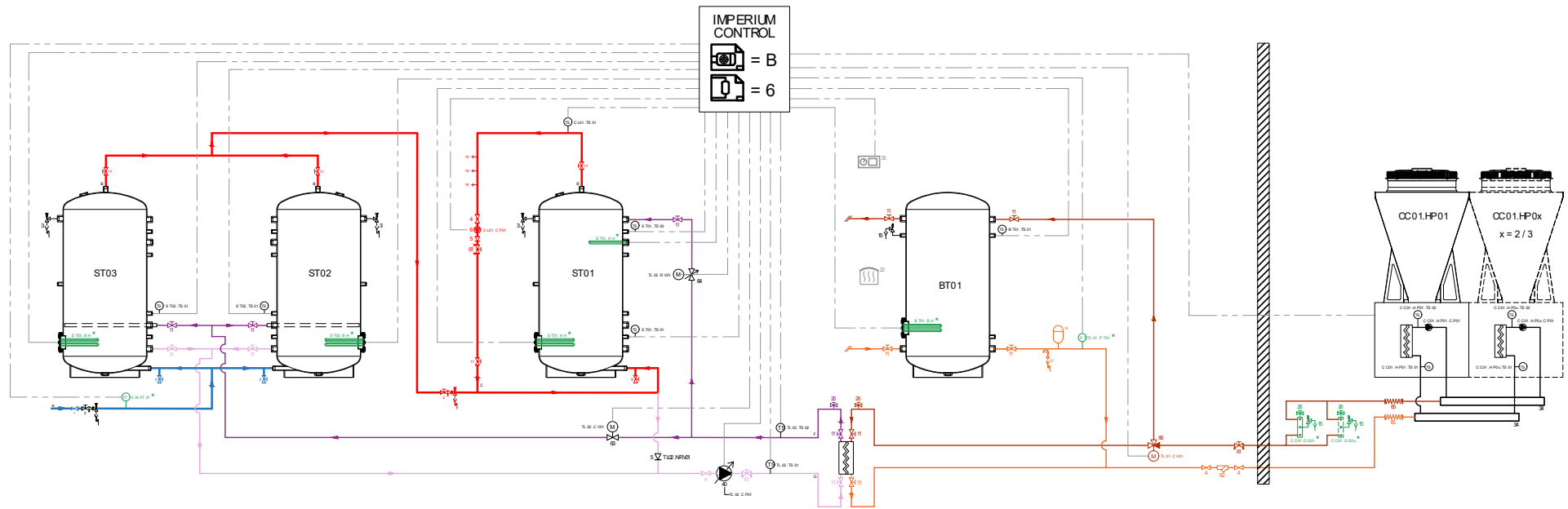

IMD-1564 R0 - IMPERIUM SYSTEM B6 (COMBI) – 3 ST PARALLEL + SERIES; MP+OP; 1 BT; 1 BANK

Terug naar [Systeemconfiguraties](#)



B.7 Combi System B7

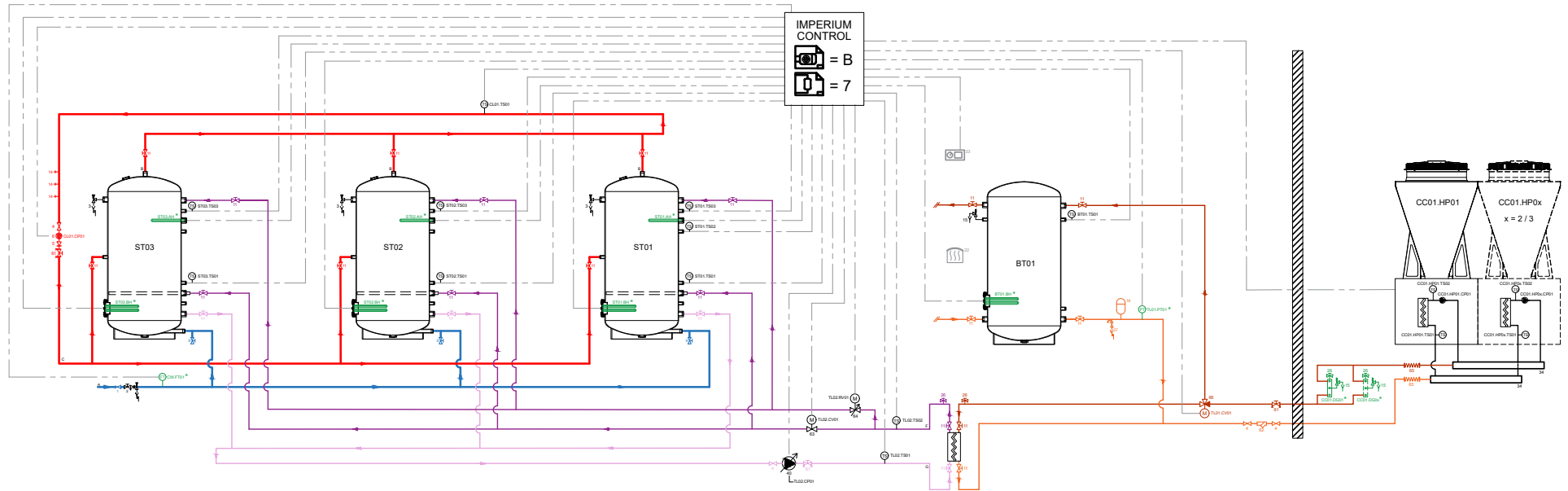

IMD-1568 R0 - IMPERIUM SYSTEM B7 (COMBI) – 3 ST PARALLEL; MP+OP; 1 BT; 1 BANK

Terug naar [Systeemconfiguraties](#)



B.8 Combi System B8

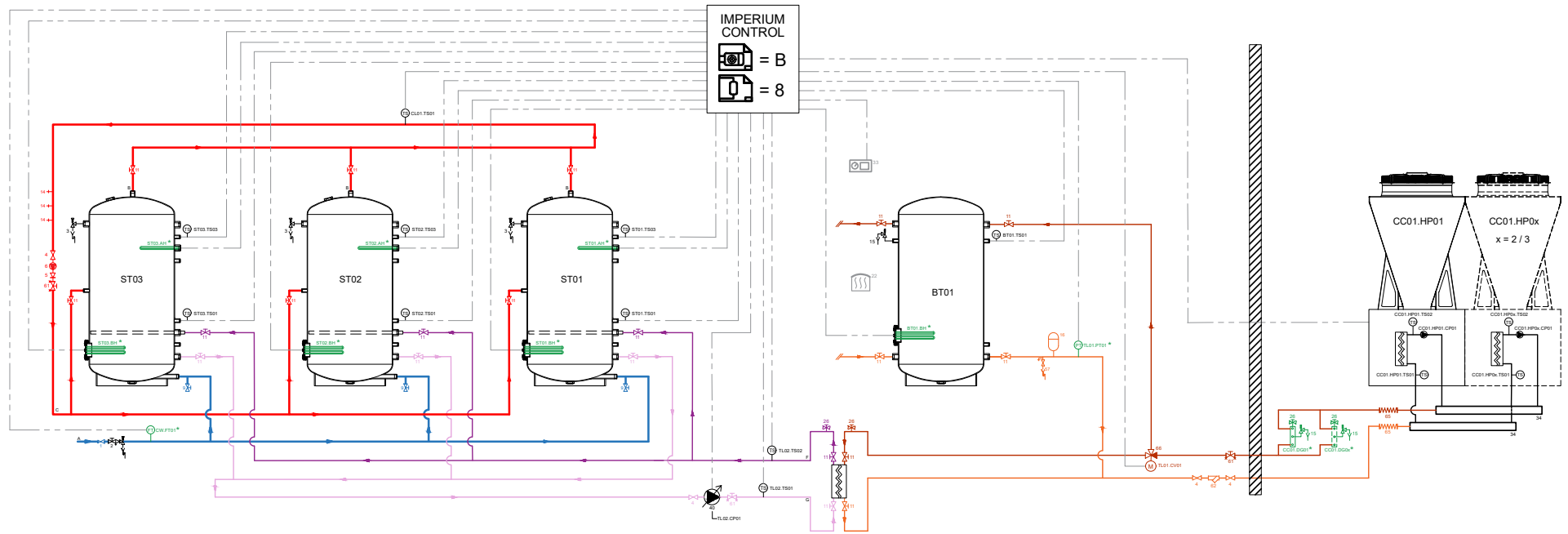

IMD-1572 R0 - IMPERIUM SYSTEM B8 (COMBI) – 3 ST PARALLEL; MP; 1 BT; 1 BANK

Terug naar [Systeemconfiguraties](#)



C.1 Combi System C1

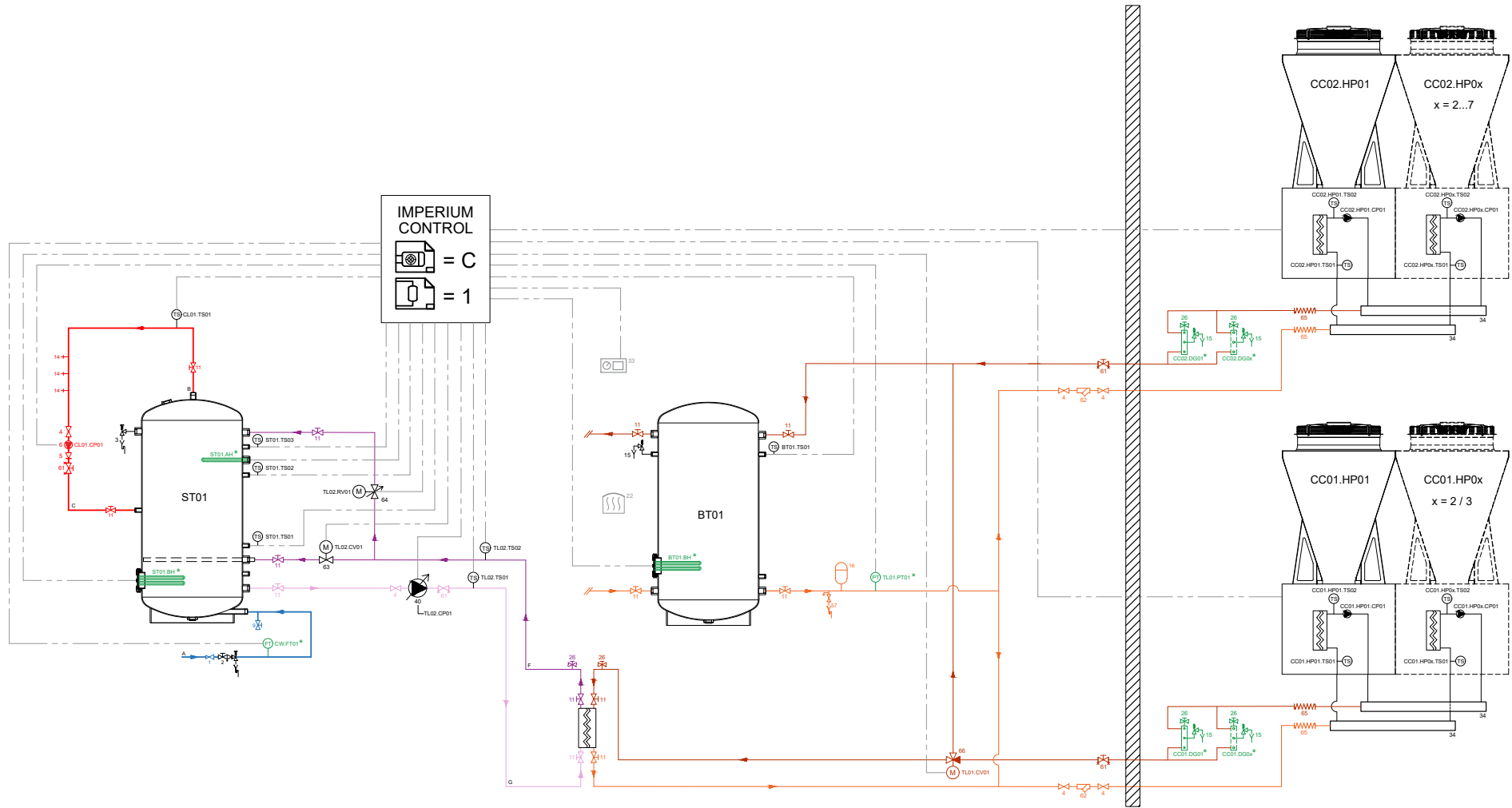

IMD-1546 R0 - IMPERIUM SYSTEM C1 (COMBI) – 1 ST; MP+OP; 1 BT; 2 BANKS

Terug naar [Systeemconfiguraties](#)



C.2 Combi System C2

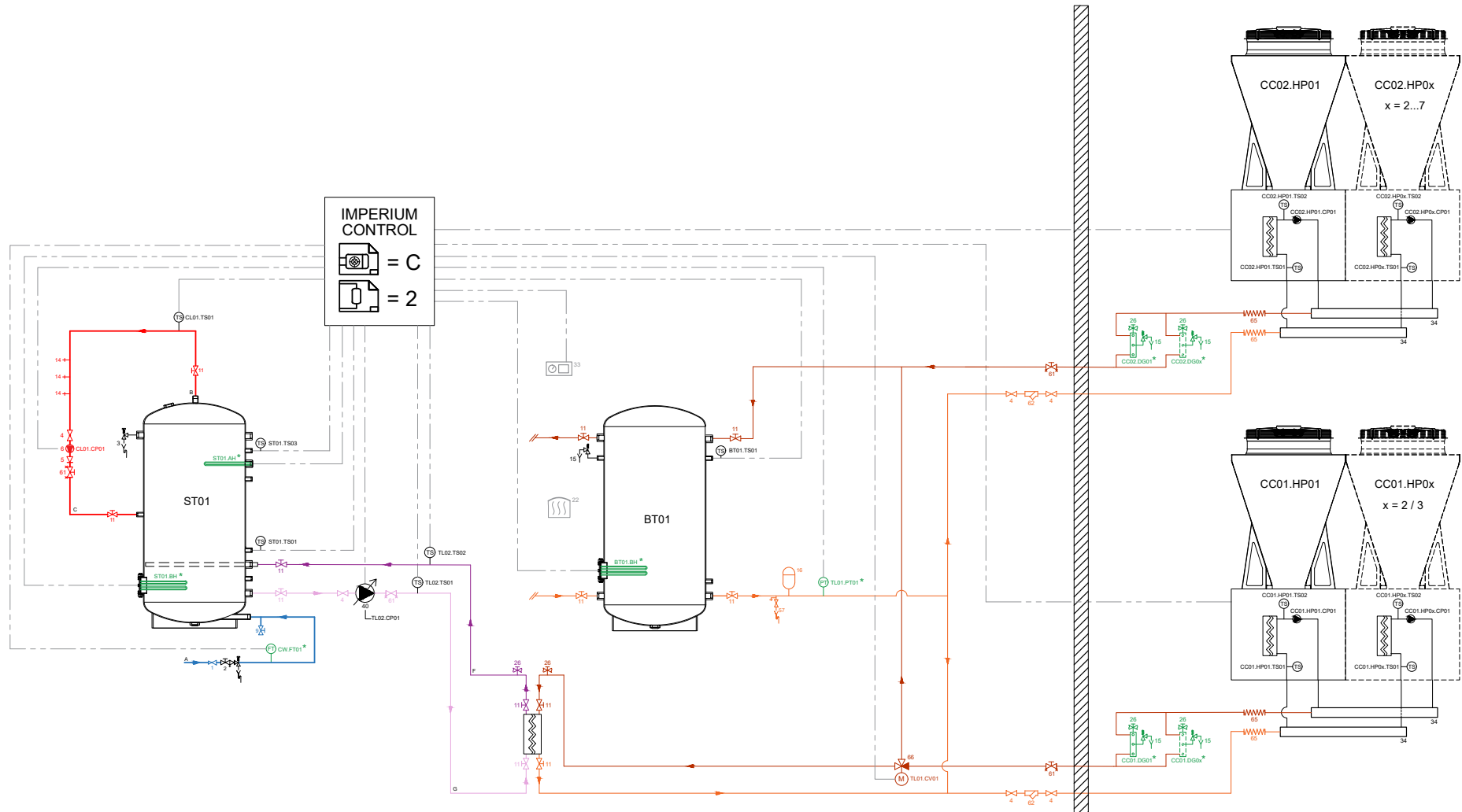

IMD-1550 R0 - IMPERIUM SYSTEM C2 (COMBI) – 1 ST; MP; 1 BT; 2 BANKS

Terug naar [Systeemconfiguraties](#)



C.3 Combi System C3

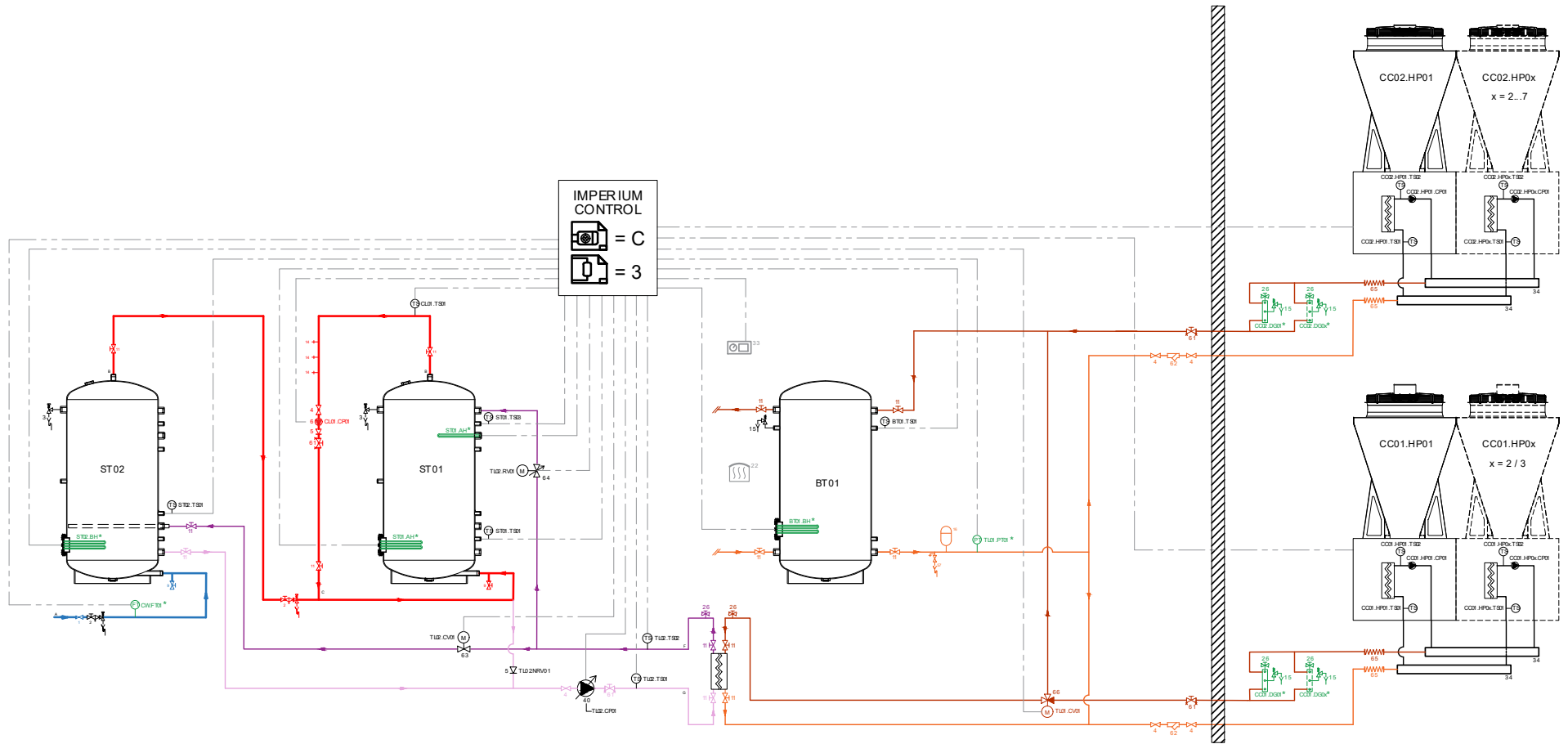

IMD-1554 R0 - IMPERIUM SYSTEM C3 (COMBI) – 2 ST SERIES; MP+OP; 1 BT; 2 BANKS

Terug naar [Systeemconfiguraties](#)



C.4 Combi System C4

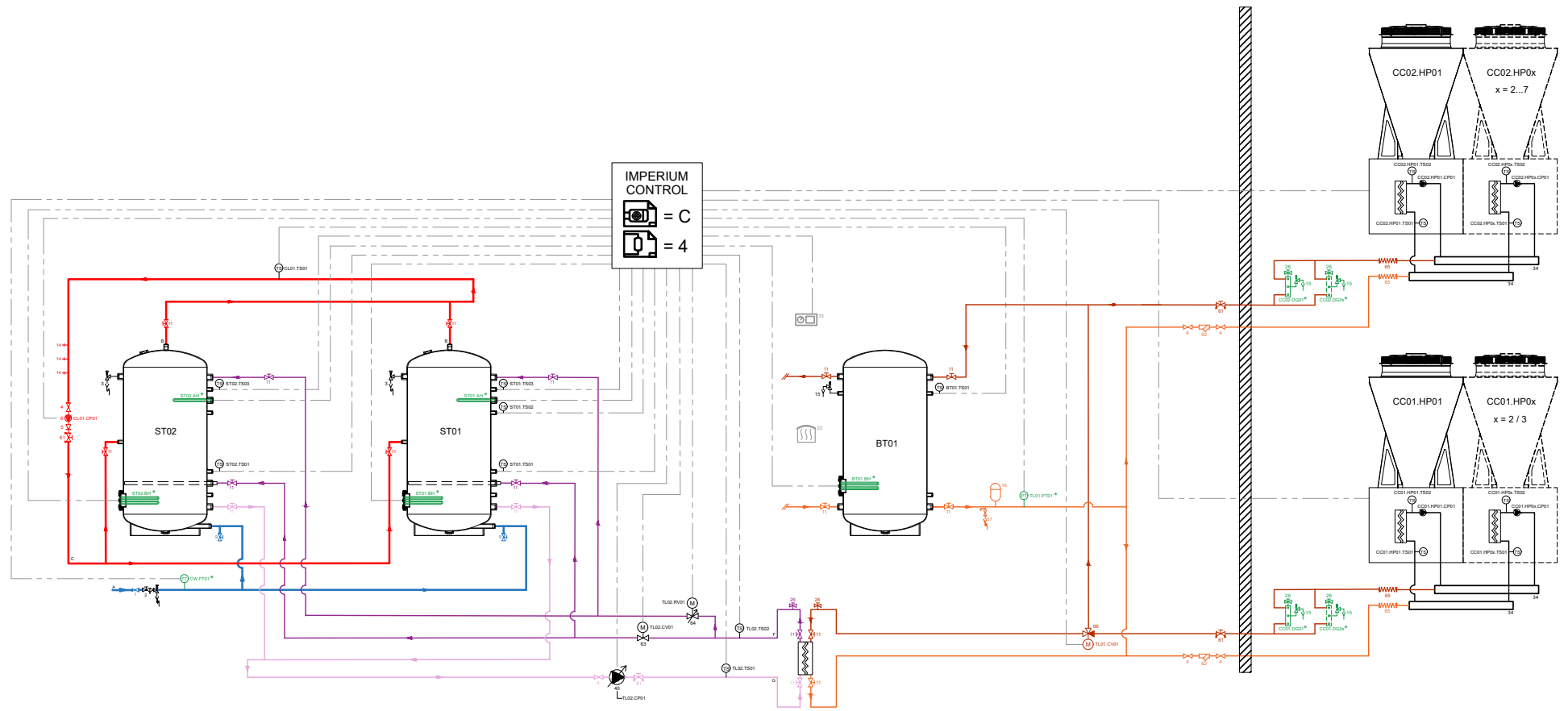

IMD-1558 R0 - IMPERIUM SYSTEM C4 (COMBI) – 2 ST PARALLEL; MP+OP; 1 BT; 2 BANKS

Terug naar [Systeemconfiguraties](#)



C.5 Combi System C5

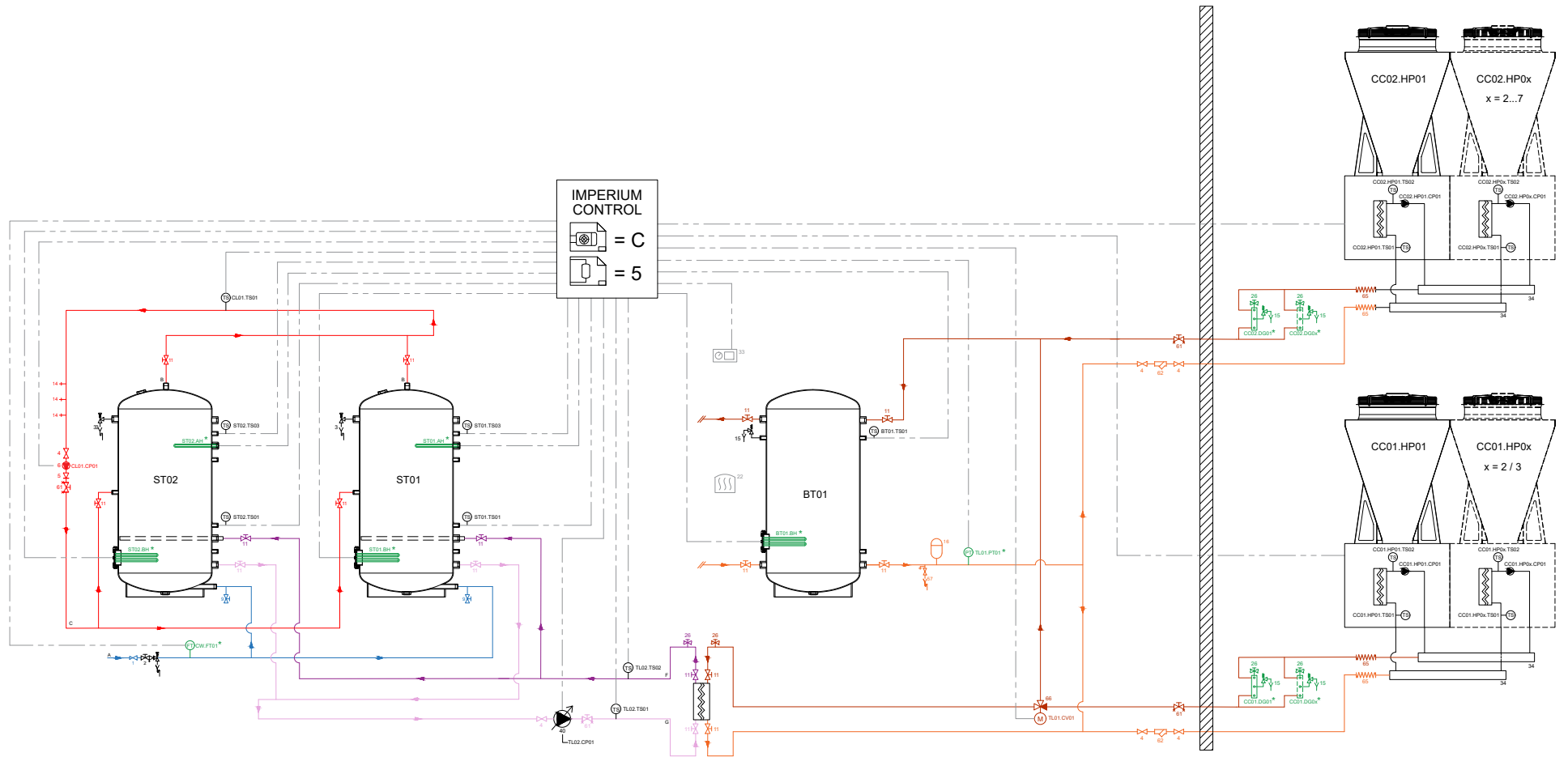

IMD-1561 R0 - IMPERIUM SYSTEM C5 (COMBI) – 2 ST PARALLEL; MP; 1 BT; 2 BANKS

Terug naar [Systemconfiguratie](#)



C.6 Combi System C6

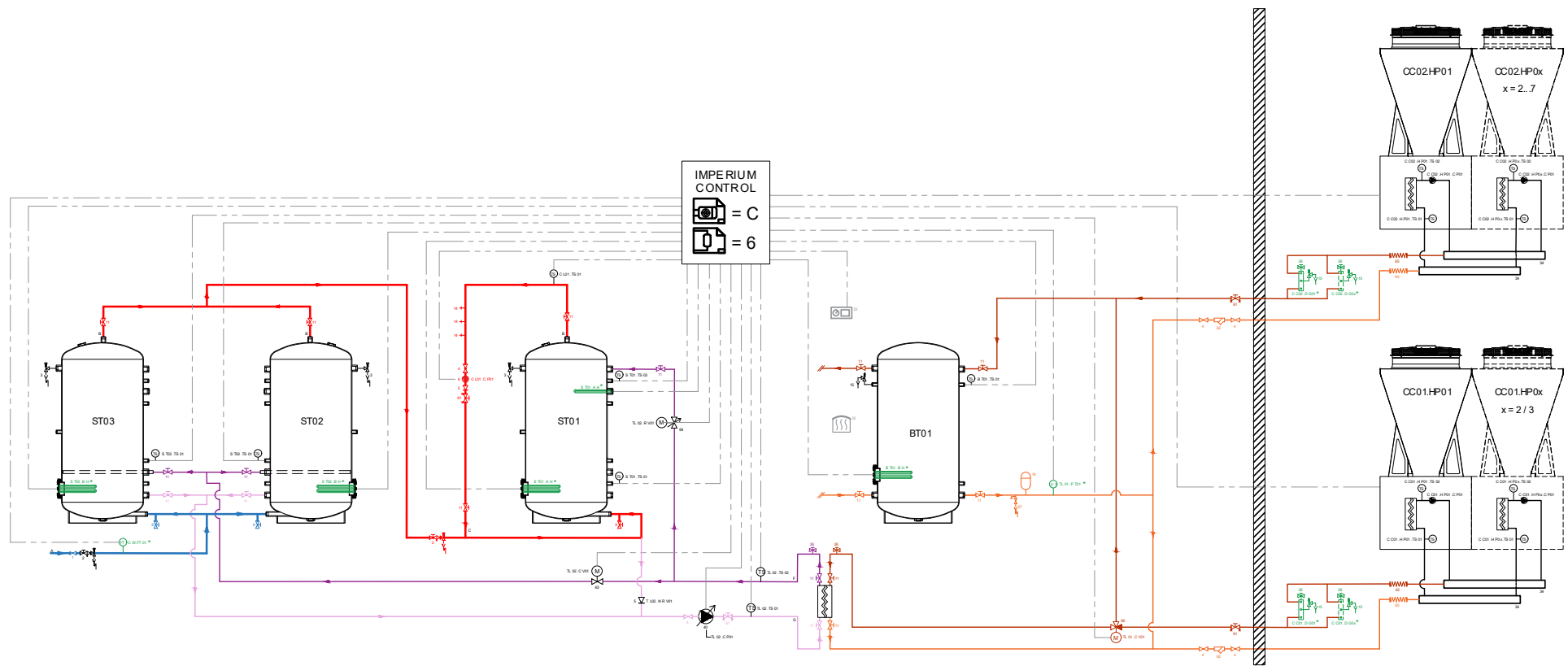

IMD-1565 R0 - IMPERIUM SYSTEM C6 (COMBI) – 3 ST PARALLEL + SERIES; MP+OP; 1 BT; 2 BANKS

Terug naar [Systeemconfiguraties](#)



C.7 Combi System C7

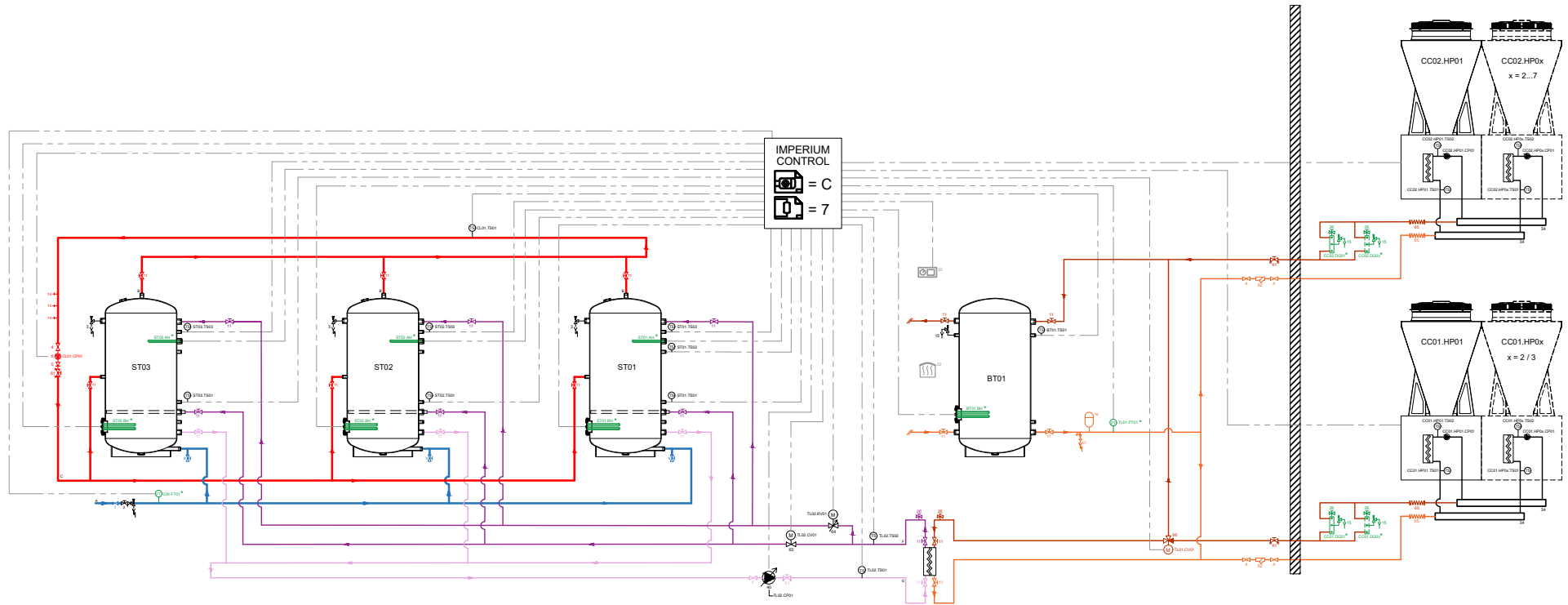

IMD-1569 R0 - IMPERIUM SYSTEM C7 (COMBI) – 3 ST PARALLEL; MP+OP; 1 BT; 2 BANKS

Terug naar [Systeemconfiguraties](#)



C.8 Combi System C8

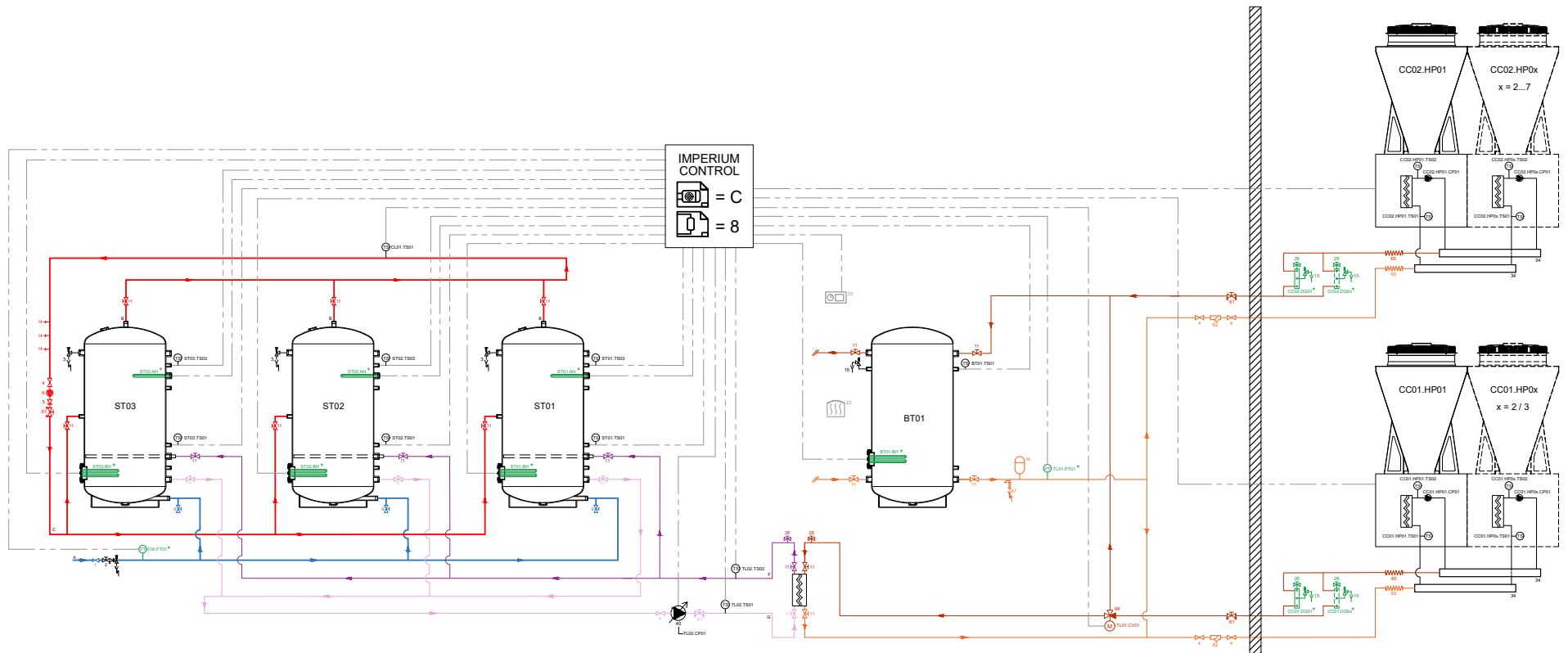

IMD-1526 R0 - IMPERIUM SYSTEM C8 (COMBI) – 3 ST PARALLEL; MP; 1 BT; 2 BANKS

Terug naar [Systeemconfiguraties](#)



D.1 Combi System D1

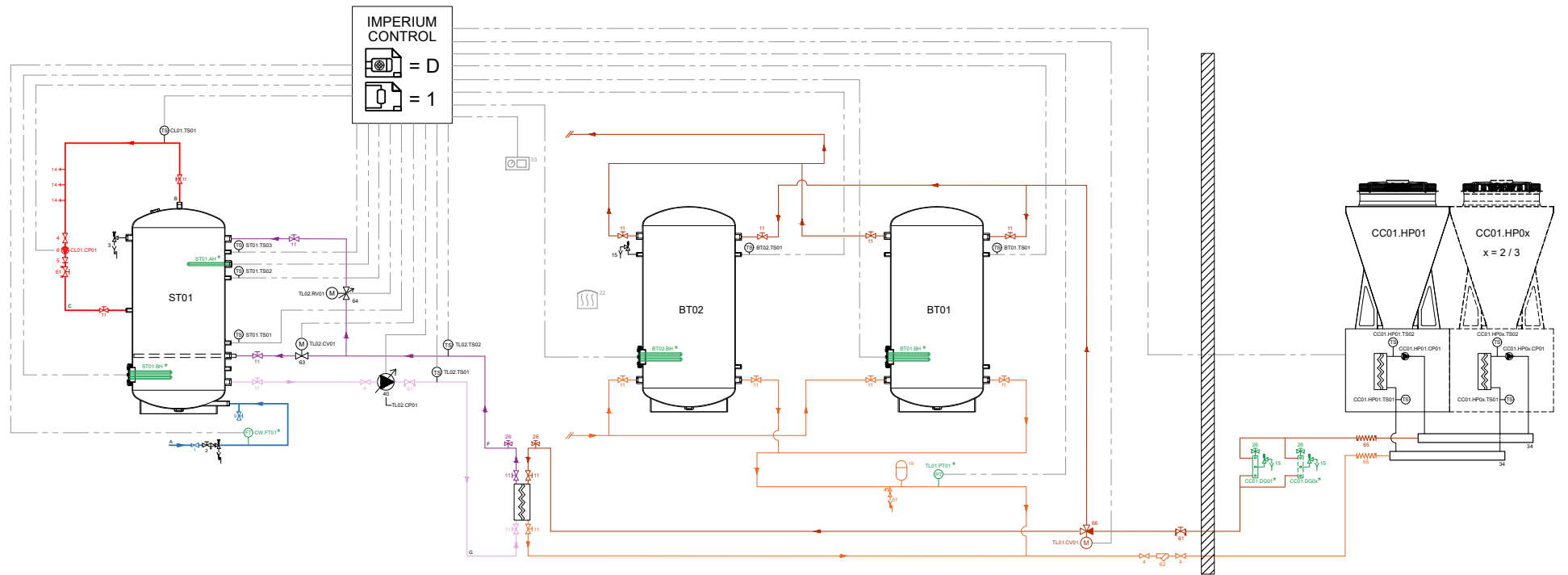

IMD-1547 R0 - IMPERIUM SYSTEM D1 (COMBI) – 1 ST; MP+OP; 2 BT; 1 BANK

Terug naar [Systeemconfiguraties](#)



D.2 Combi System D2

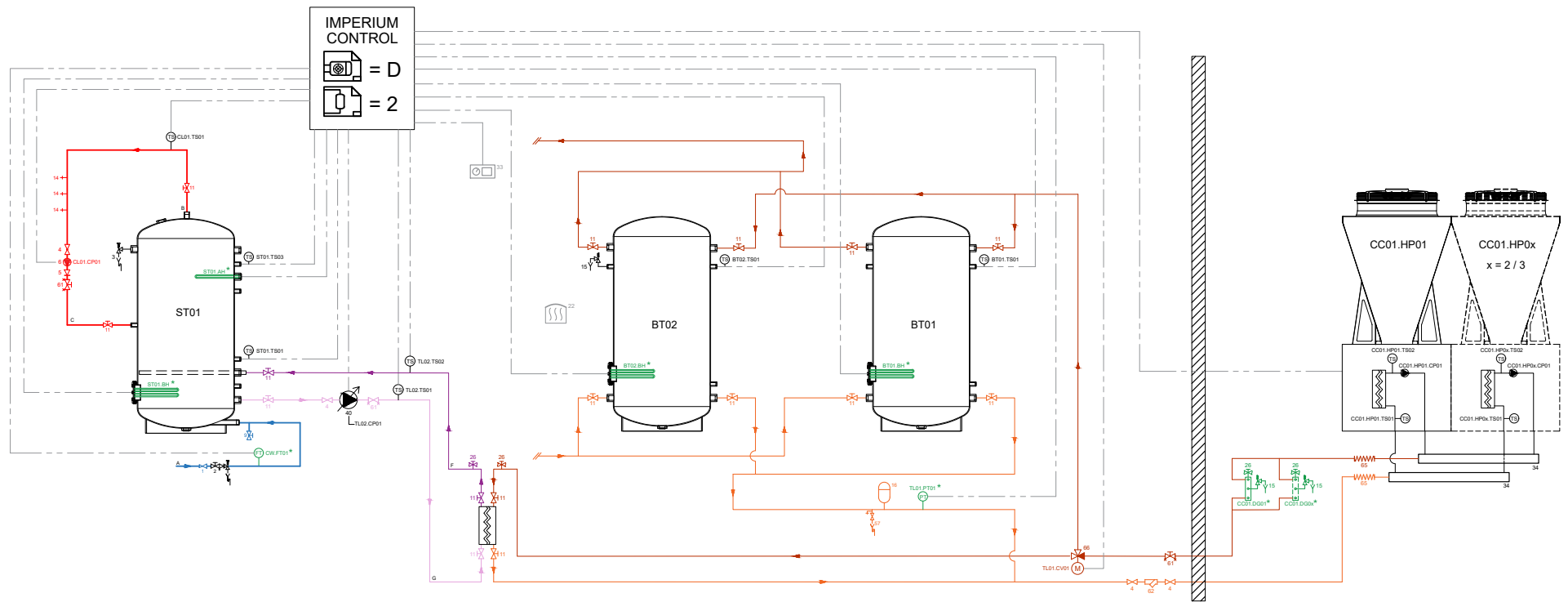

IMD-1551 R0 - IMPERIUM SYSTEM D2 (COMBI) – 1 ST; MP; 2 BT; 1 BANK

Terug naar [Systeemconfiguraties](#)



D.3 Combi System D3

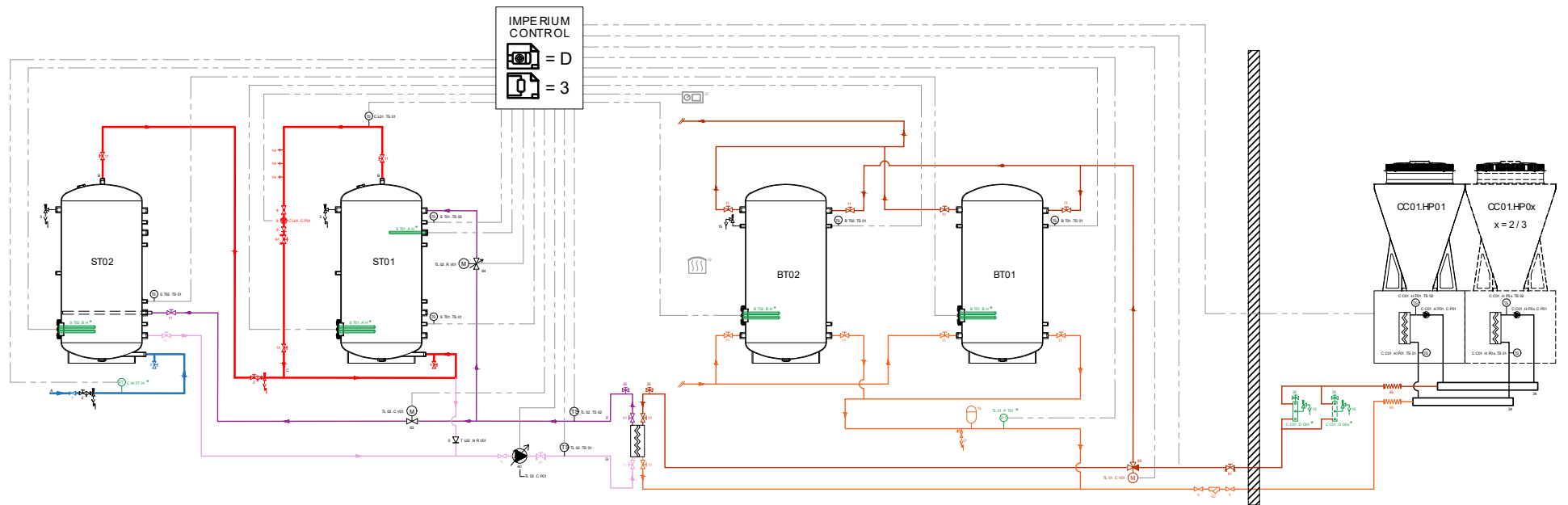

IMD-1555 R0 - IMPERIUM SYSTEM D3 (COMBI) – 2 ST SERIES; MP+OP; 2 BT; 1 BANK

Terug naar [Systeemconfiguraties](#)



D.4 Combi System D4

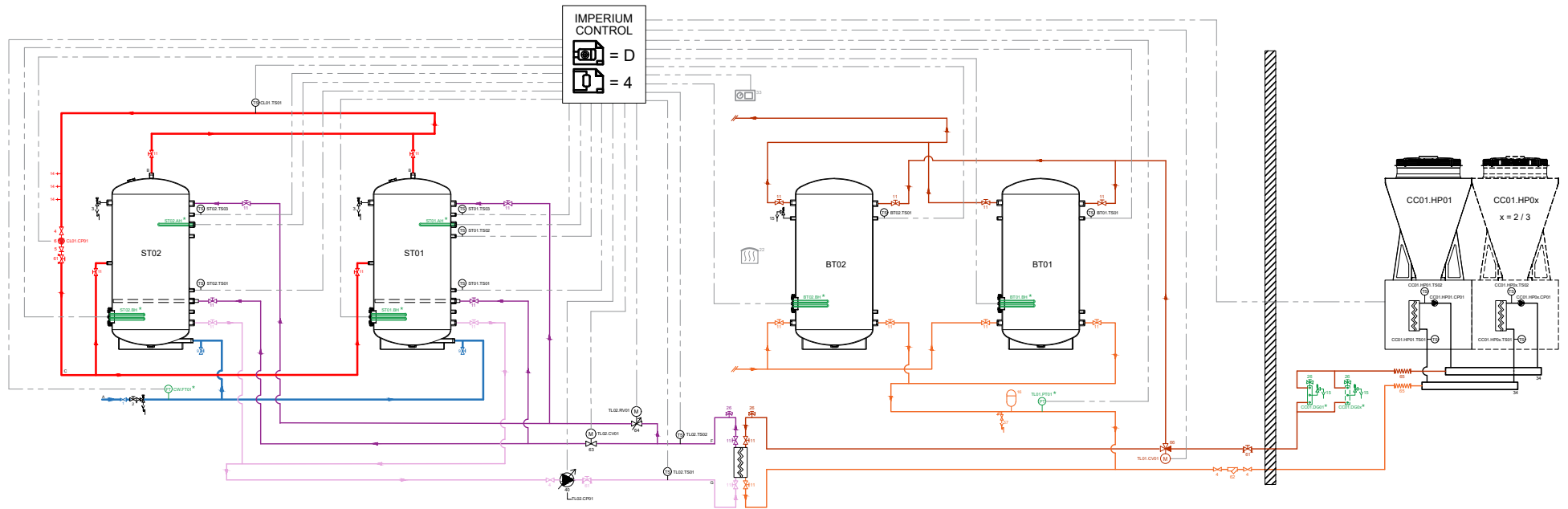

IMD-1559 R0 - IMPERIUM SYSTEM D4 (COMBI) – 2 ST PARALLEL; MP+OP; 2 BT; 1 BANK

Terug naar [Systeemconfiguraties](#)



D.5 Combi System D5

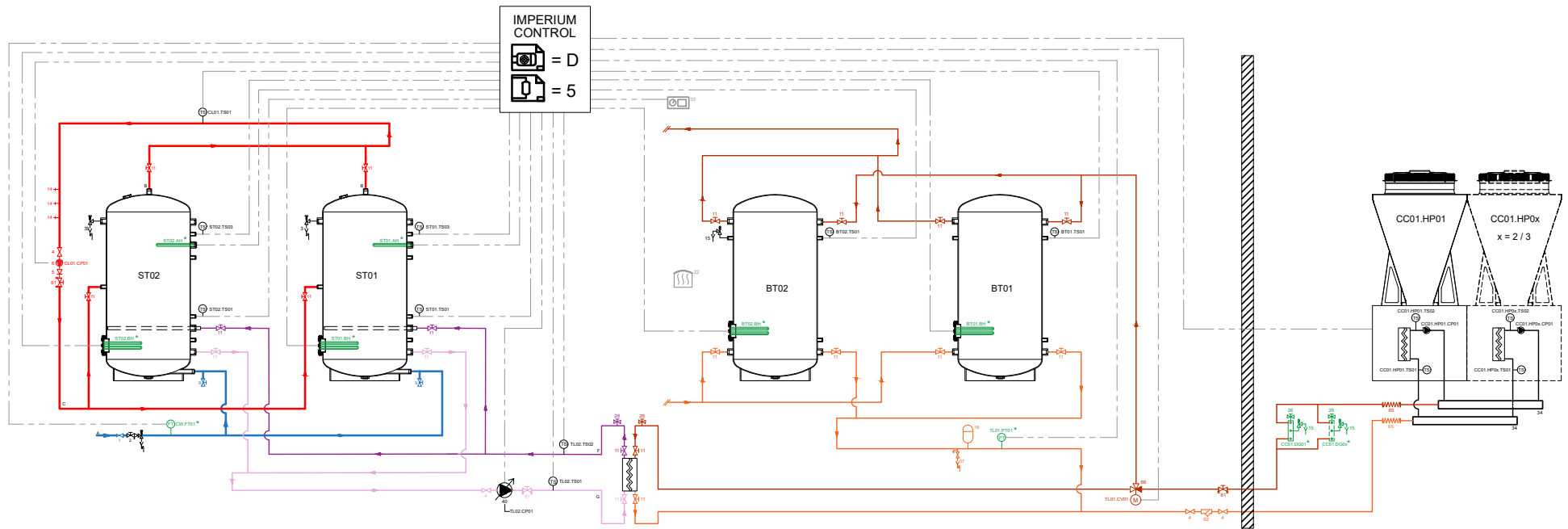

IMD-1562 R0 - IMPERIUM SYSTEM D5 (COMBI) – 2 ST PARALLEL; MP; 2 BT; 1 BANK

Terug naar [Systeemconfiguraties](#)



D.6 Combi System D6

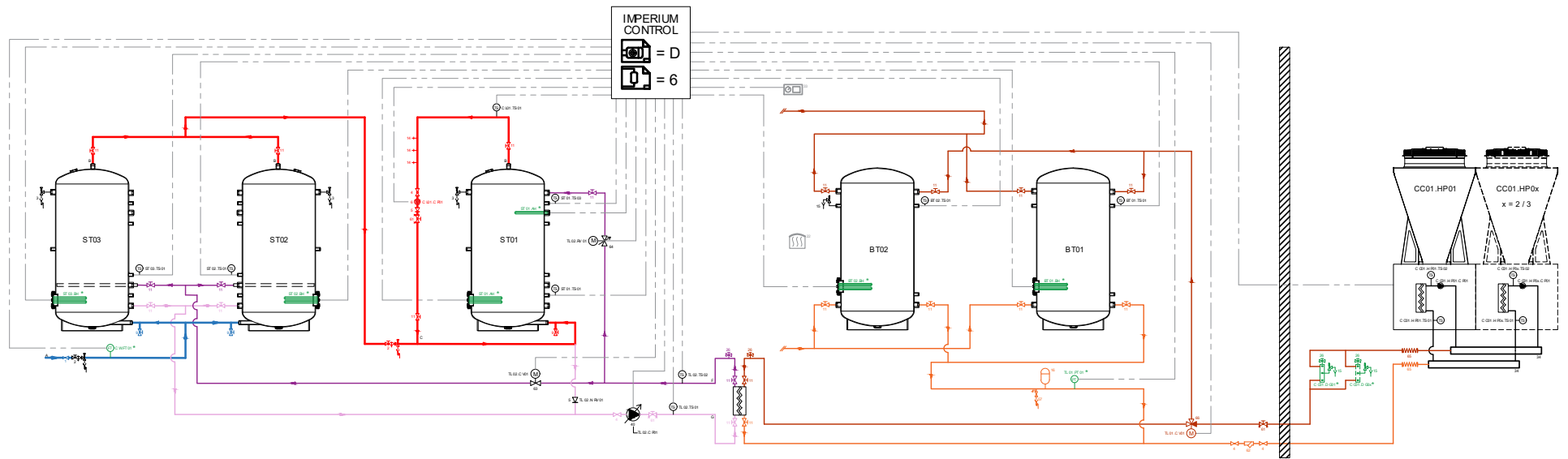

IMD-1566 R0 - IMPERIUM SYSTEM D6 (COMBI) – 3 ST PARALLEL + SERIES; MP+OP; 2 BT; 1 BANK

Terug naar [Systeemconfiguraties](#)



D.7 Combi System D7

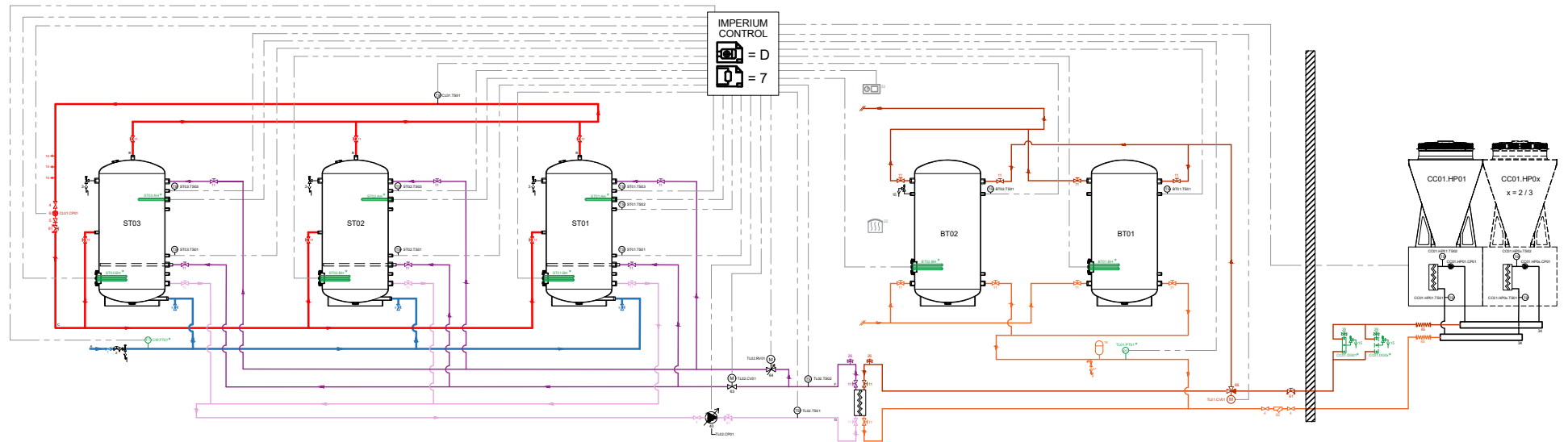

IMD-1570 R0 - IMPERIUM SYSTEM D7 (COMBI) – 3 ST PARALLEL; MP+OP; 2 BT; 1 BANK

Terug naar [Systeemconfiguraties](#)



D.8 Combi System D8

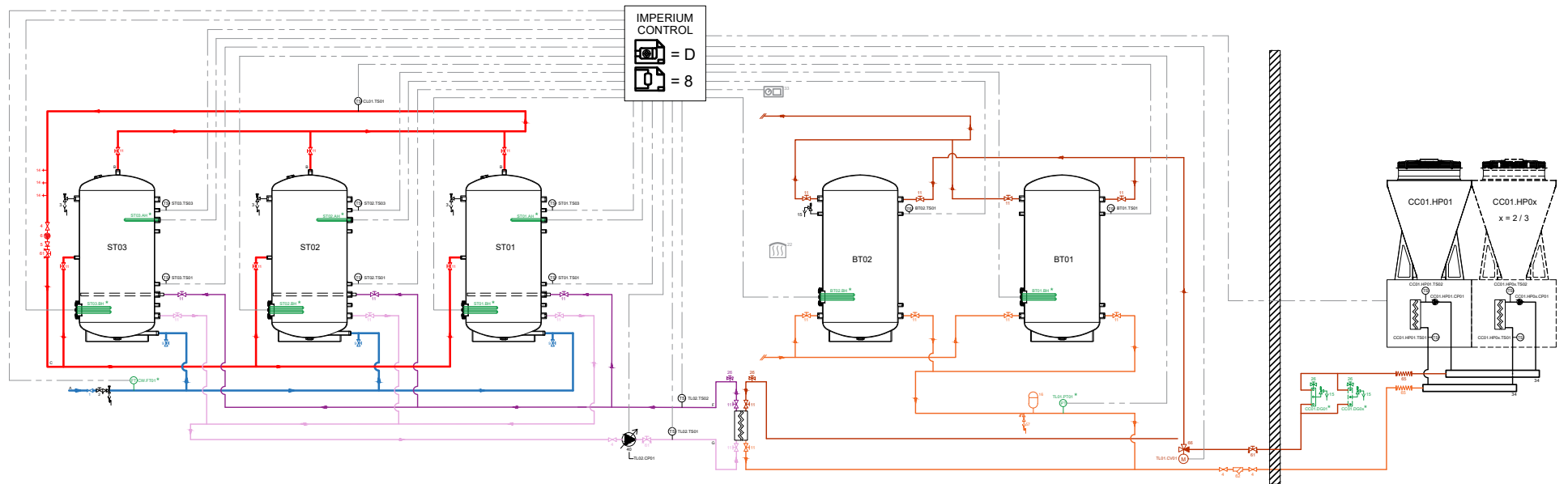

IMD-1573 R0 - IMPERIUM SYSTEM D8 (COMBI) – 3 ST PARALLEL; MP; 2 BT; 1 BANK

Terug naar [Systeemconfiguraties](#)



E.1 Combi System E1

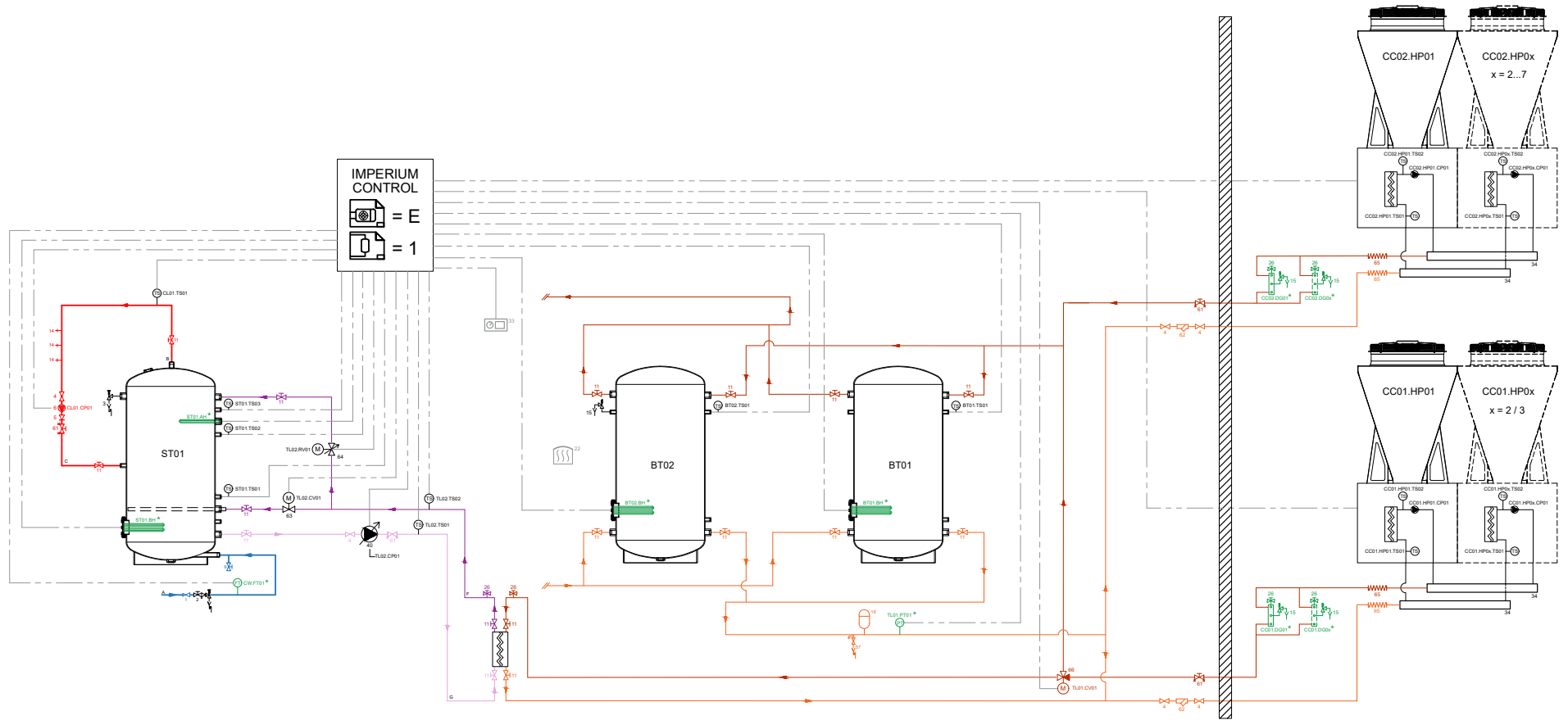

IMD-1548 R0 - IMPERIUM SYSTEM E1 (COMBI) – 1 ST; MP+OP; 2 BT; 2 BANKS

Terug naar [Systeemconfiguraties](#)



E.2 Combi System E2

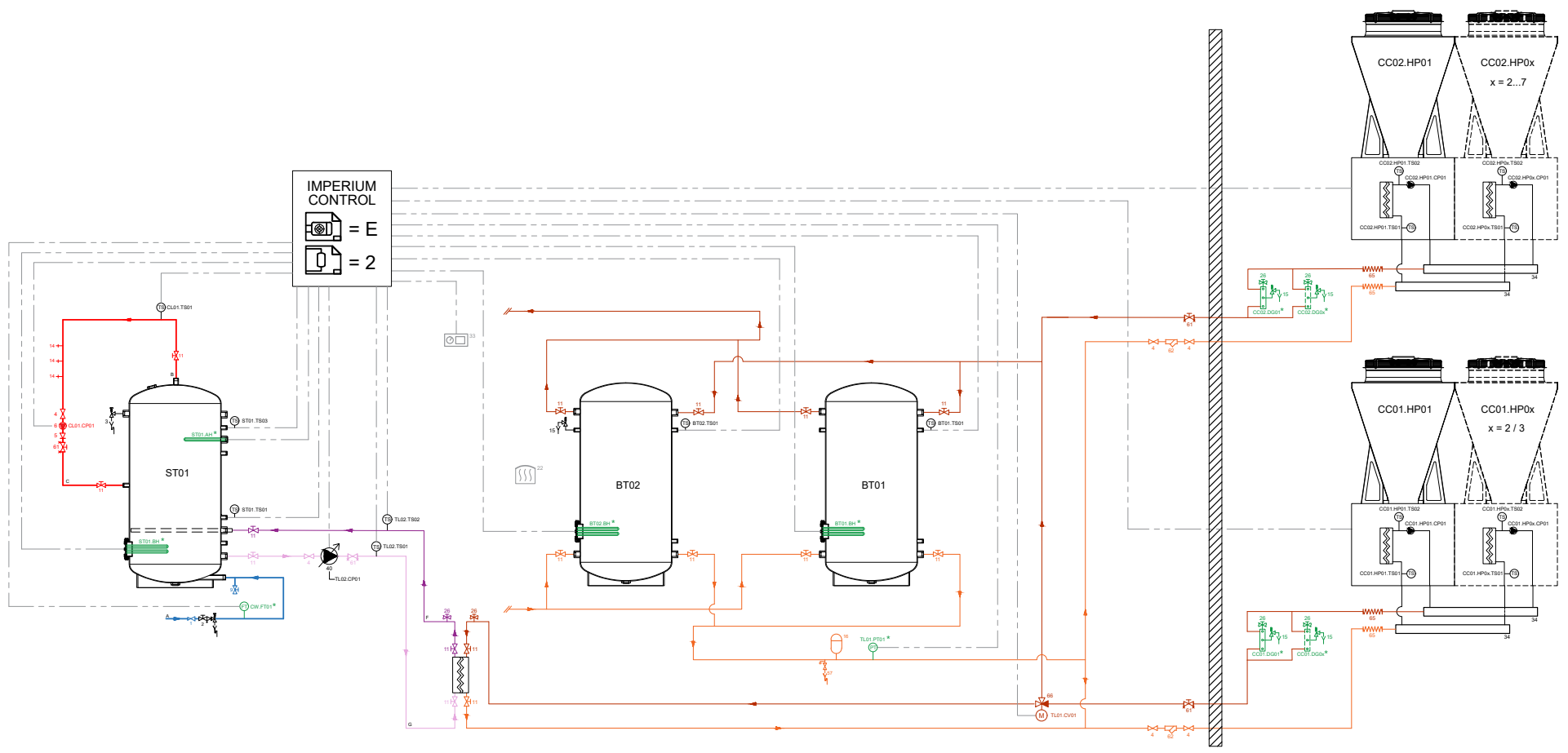

IMD-1552 R0 - IMPERIUM SYSTEM E2 (COMBI) – 1 ST; MP; 2 BT; 2 BANKS

Terug naar [Systeemconfiguraties](#)



E.3 Combi System E3

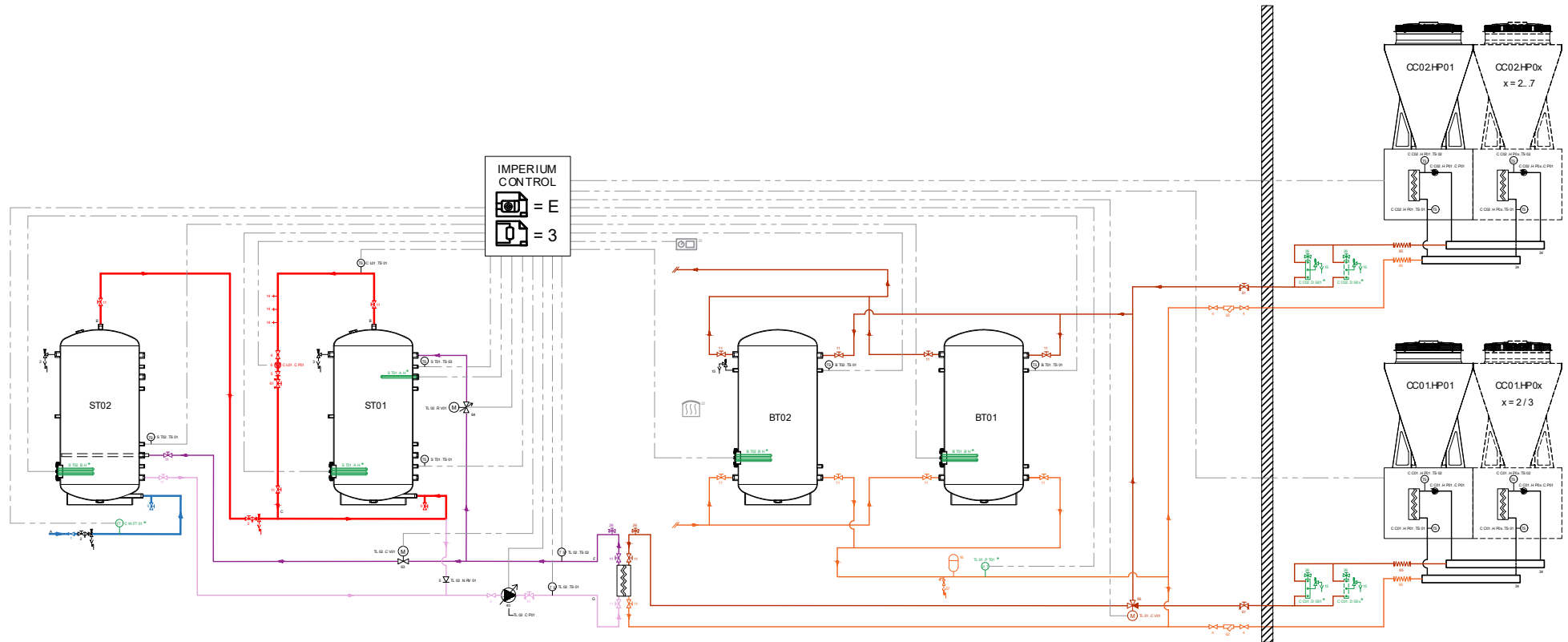

IMD-1556 R0 - IMPERIUM SYSTEM E3 (COMBI) – 2 ST SERIES; MP+OP; 2 BT; 2 BANKS

Terug naar [Systeemconfiguraties](#)



E.4 Combi System E4

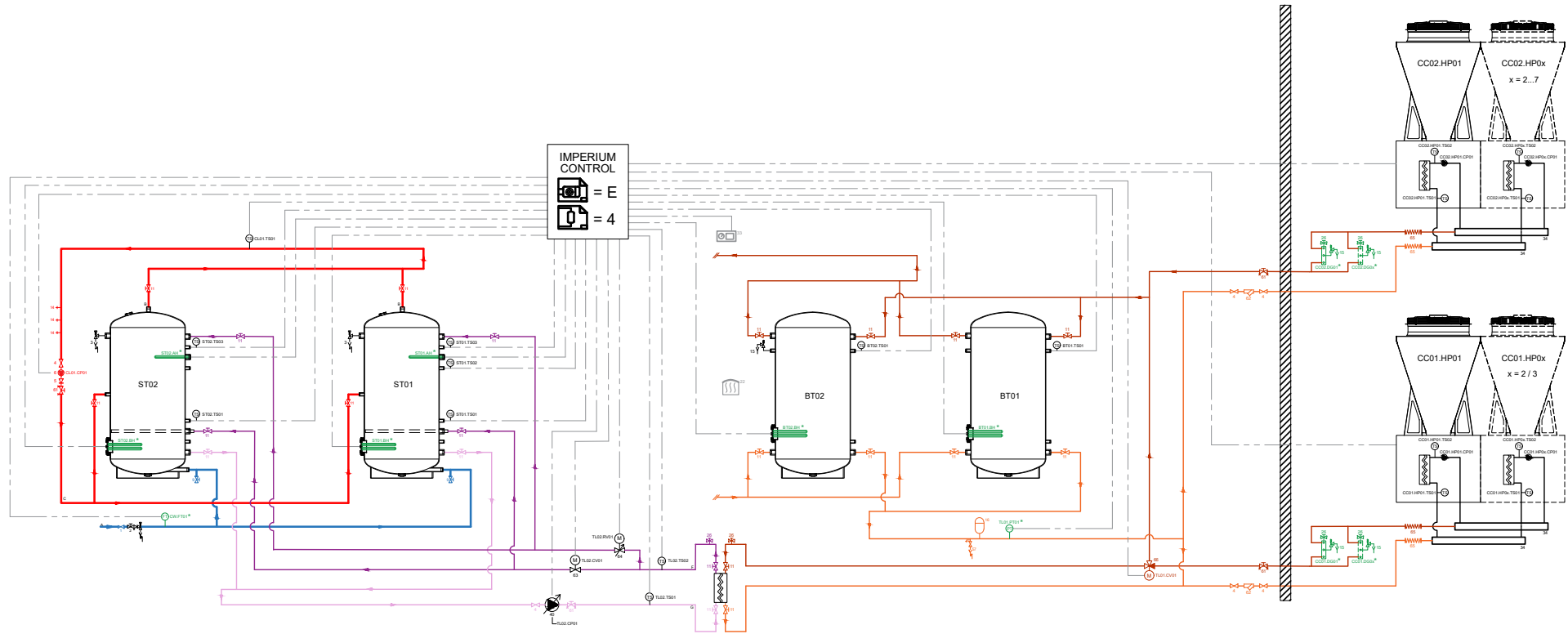

IMD-1560 R0 - IMPERIUM SYSTEM E4 (COMBI) – 2 ST PARALLEL; MP+OP; 2 BT; 2 BANKS

Terug naar [Systeemconfiguraties](#)



E.5 Combi System E5

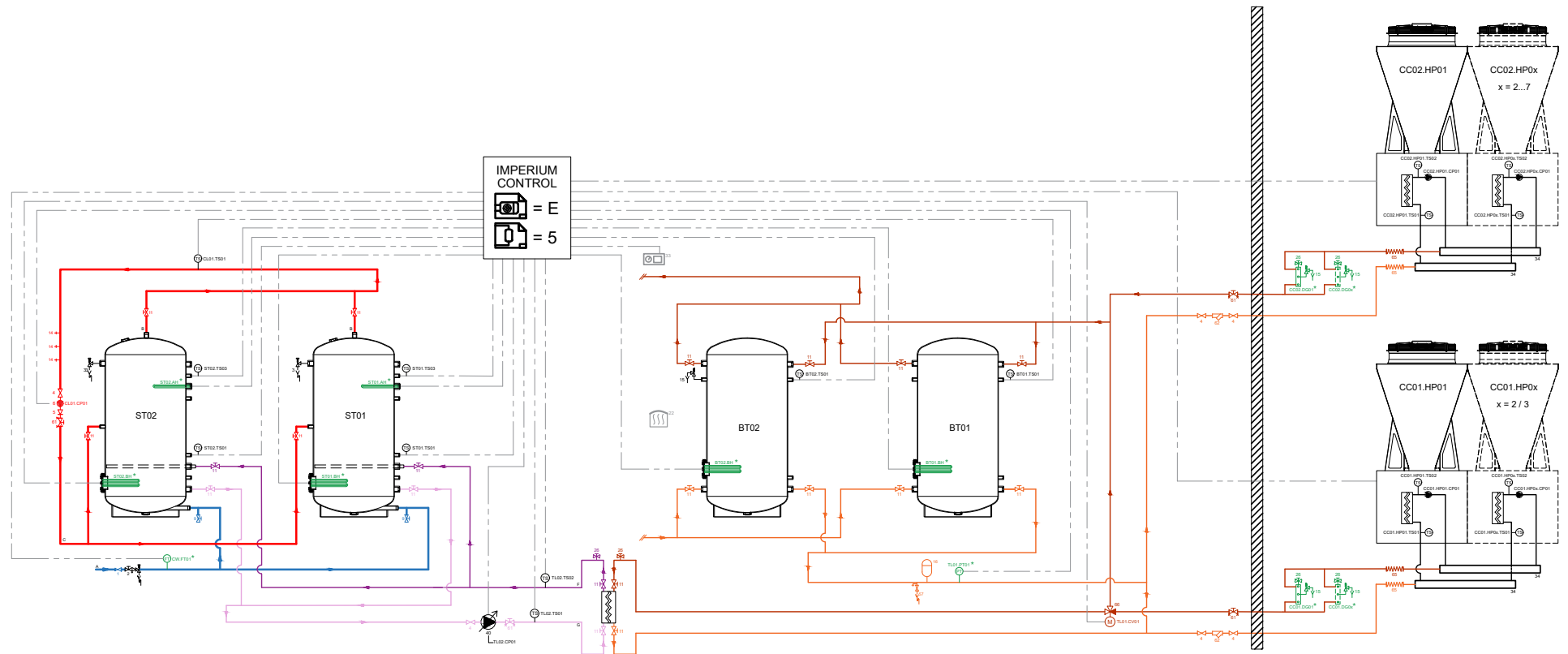

IMD-1563 R0 - IMPERIUM SYSTEM E5 (COMBI) – 2 ST PARALLEL; MP; 2 BT; 2 BANKS

Terug naar [Systeemconfiguraties](#)



E.6 Combi System E6

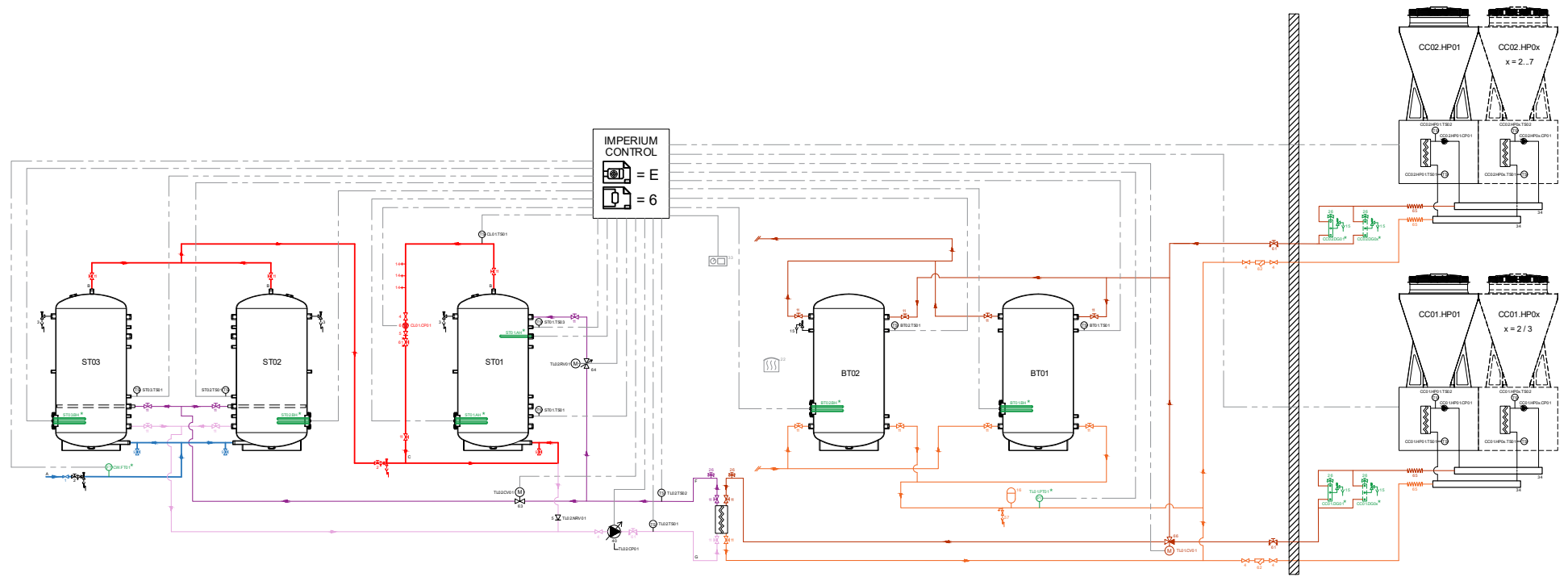

IMD-1567 R0 - IMPERIUM SYSTEM E6 (COMBI) – 3 ST PARALLEL + SERIES; MP+OP; 2 BT; 2 BANKS

Terug naar [Systeemconfiguraties](#)



E.7 Combi System E7

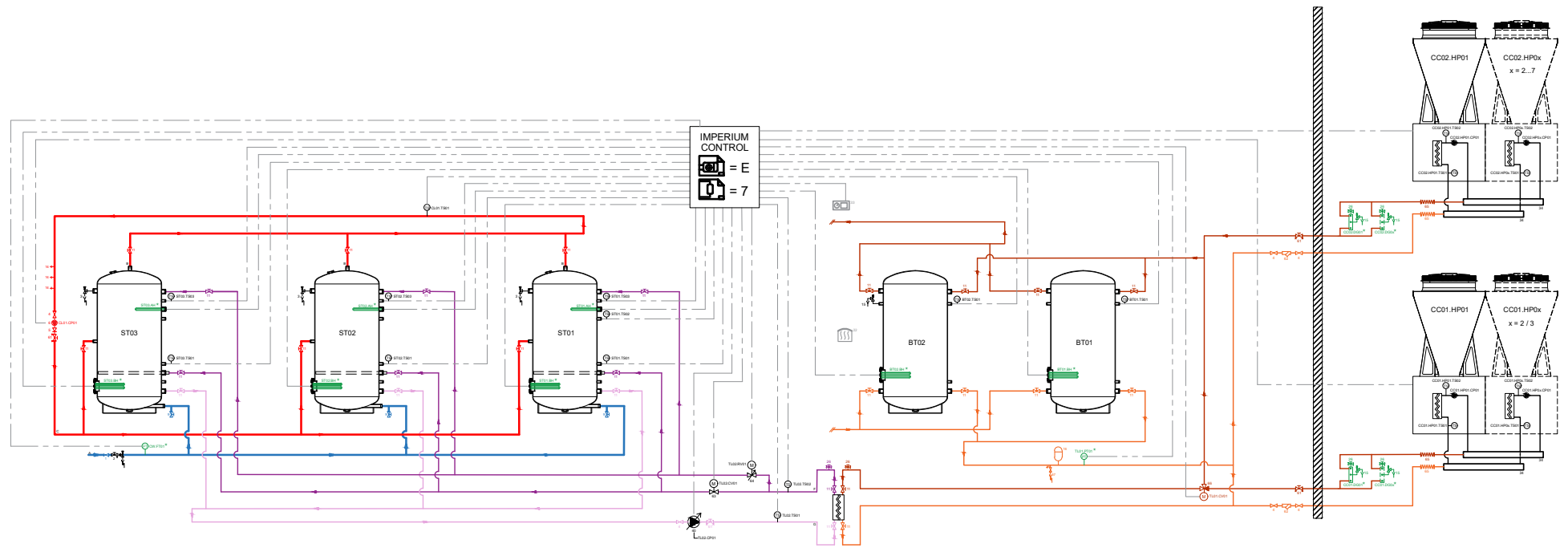

IMD-1571 R0 - IMPERIUM SYSTEM E7 (COMBI) – 3 ST PARALLEL; MP+OP; 2 BT; 2 BANKS

Terug naar [Systeemconfiguraties](#)



E.8 Combi System E8

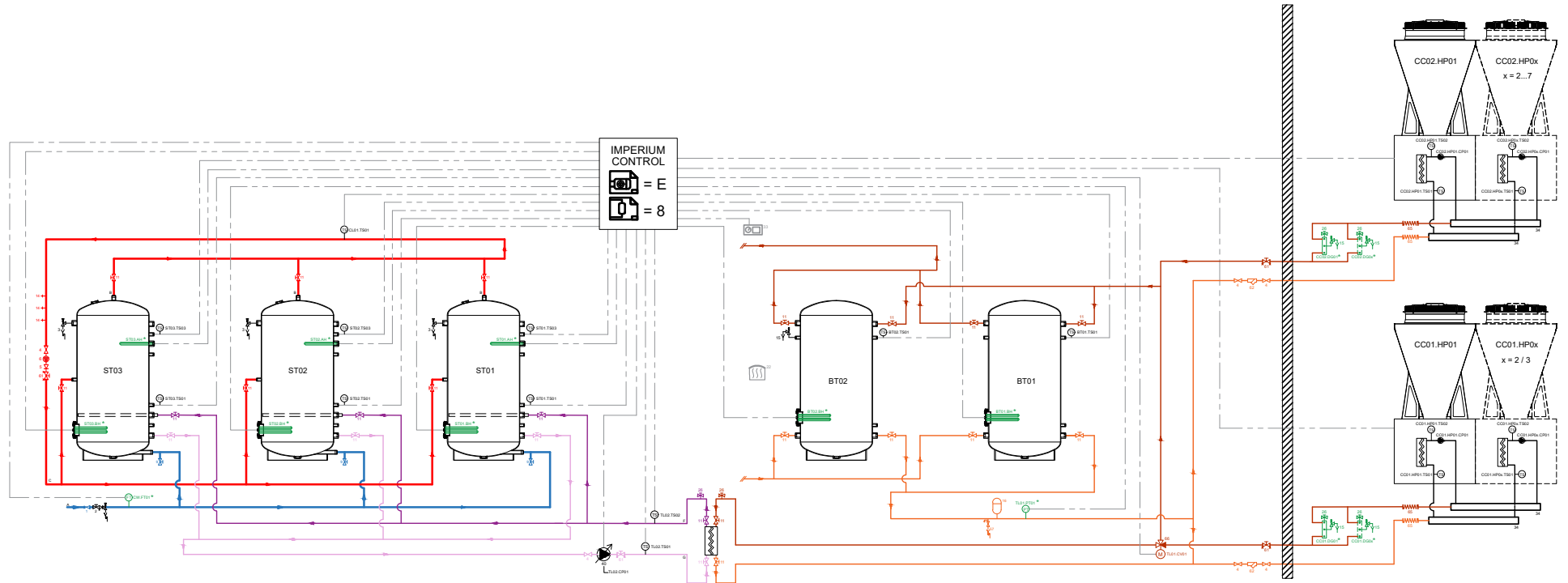

IMD-1574 R0 - IMPERIUM SYSTEM E8 (COMBI) – 3 ST PARALLEL; MP; 2 BT; 2 BANKS

Terug naar [Systeemconfiguraties](#)



F CH System F

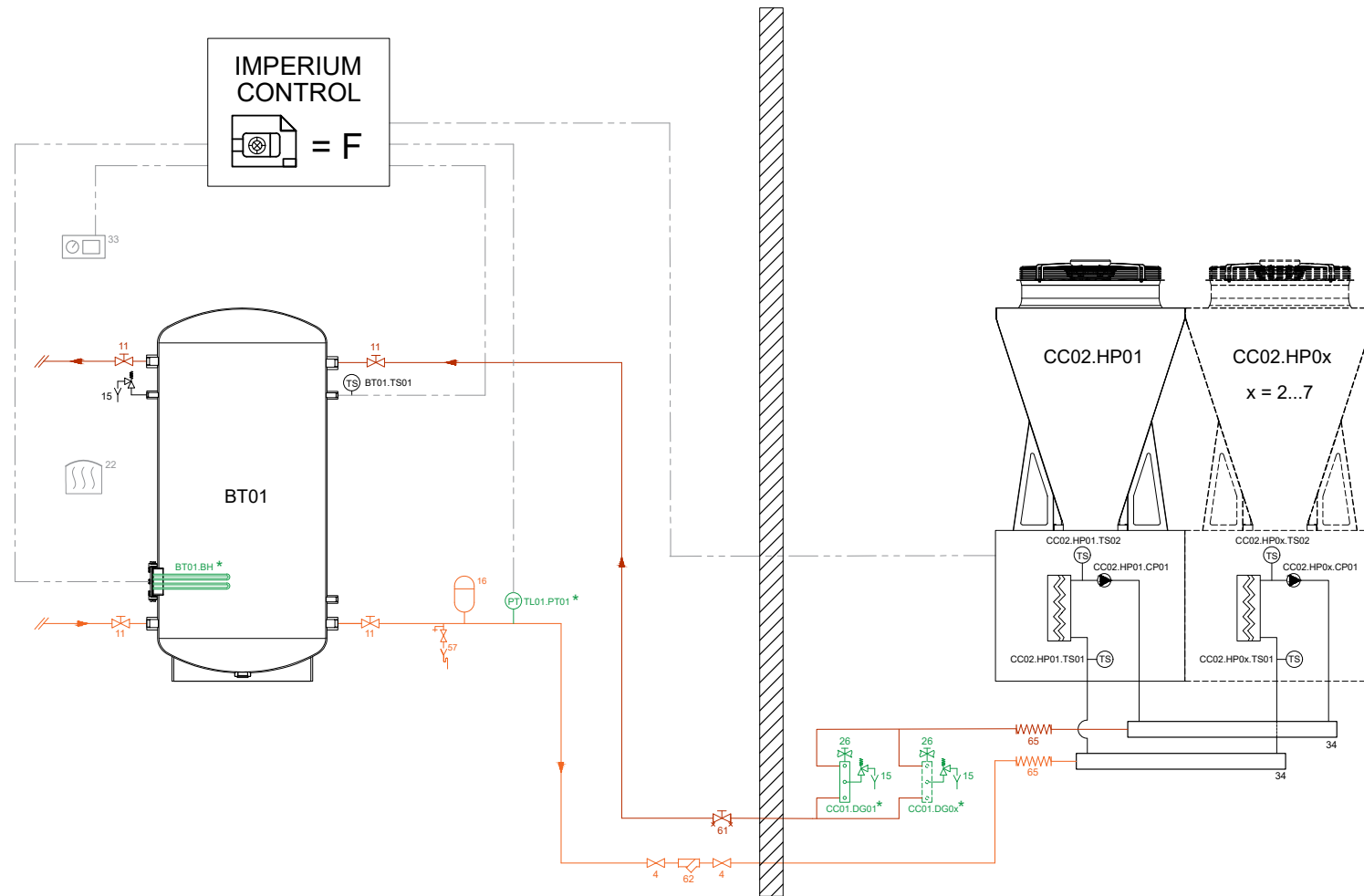

IMD-1518 R0 - IMPERIUM SYSTEM F (CH) – 1 BT; 1 BANK

Terug naar [Systeemconfiguraties](#)



G CH System G

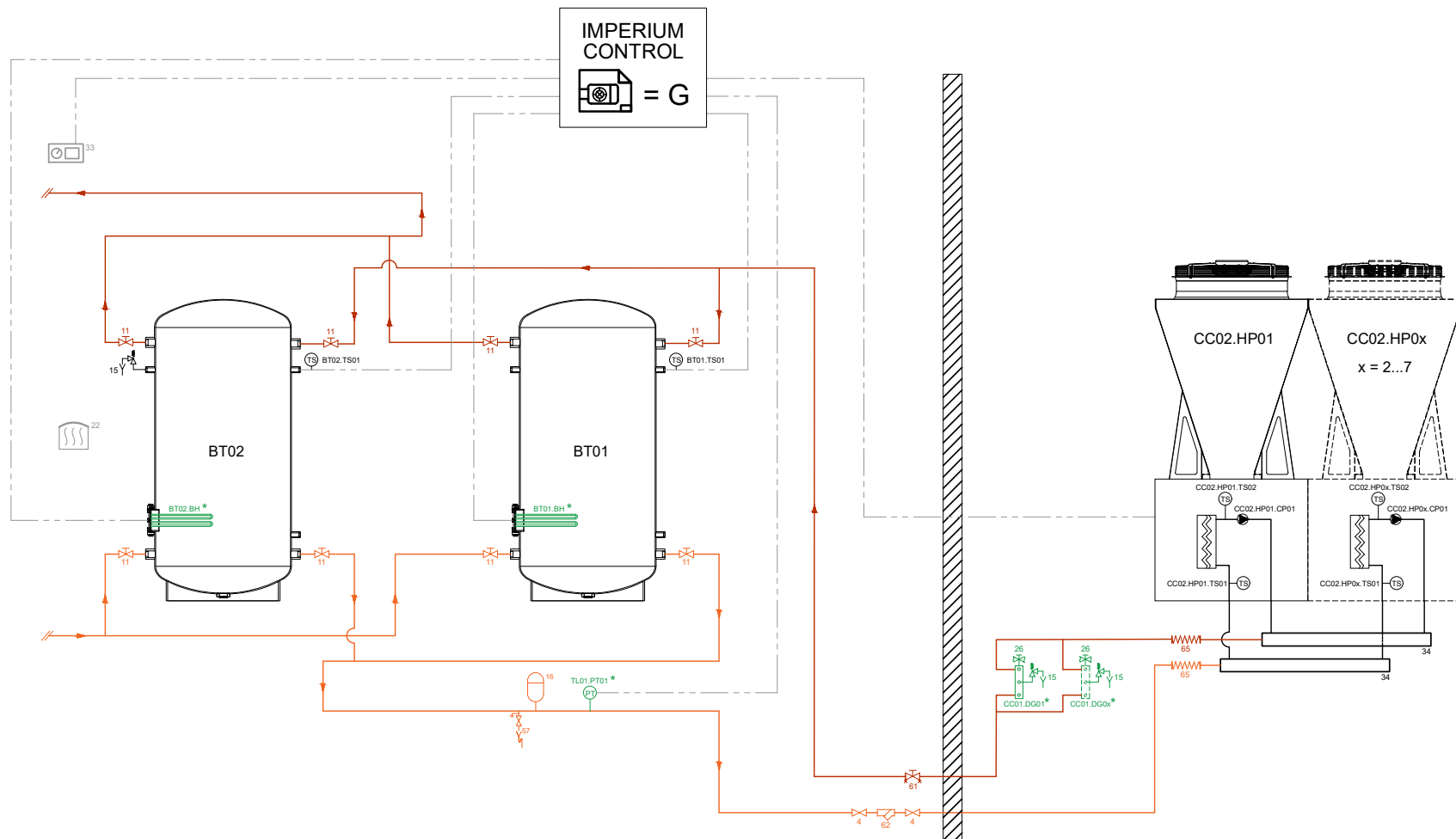

IMD-1519 R0 - IMPERIUM SYSTEM G (CH) – 2 BT; 1 BANK

Terug naar [Systeemconfiguraties](#)

